

44
December
1986

elektor **INDIA**

Rs. 7.50

electronics

**Top-of-the-range
preamplifier**

Srinivas Reddy



Sensitive light meter
The battle for supertelevision
Indoor unit for satellite TV reception-2

VASAVI's VLCR7 SAVES YOU FROM AGONY OF BRIDGES.



Measurement of **INDUCTANCE, CAPACITANCE, RESISTANCE** are greatly simplified by **VLCR 7**. No balancing, no adjustments. **VLCR 7** gives you directly the digital reading of value and its loss factor simultaneously. **VLCR 7** is the only instrument in India covering the widest ranges of 0.1 pf/uH/m ohm (ie. 0.0001 ohm) to 20,000 uf/200H/20 M ohm.

VASAVI OSCILLOSCOPES

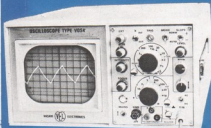

Component tester in our oscilloscopes is altogether different from other's. In addition to all Oscilloscope functions component tester provision can test all components passive and active, in circuit and out of circuit. **ONLY OUR SCOPESCAN** recognise NPN/PNP. Distinguish HIGH/LOW Gain, Distinguish AUDIO, R.F., SWITCHING transistors.

DIGITAL FREQUENCY COUNTER VDC 18



Smallest size ever made in INDIA

Battery cum mains operated wide frequency range 30MHz
(our model VDC 19 is Basic sensitivity of 10mv
Bright LED display 7 digit



MULTI FUNCTION OSCILLATOR



- * Pure Sine wave output.
- * Amplitude settable with ease down to millivolts. X 1, X 1/10 and X 1/100 attenuated outputs available.
- * No amplitude bounce when frequency varied.

VASAVI ELECTRONICS

(Marketing division)
630, Alkarim Trade Centre, Ranigunj
SECUNDERABAD-500 003.

ph: 70995
gms: VELSCOPE

Dear friends,

Way back in 1974, someone gave me issue No 5 of Elektor Magazine as a gift. I found it to be so interesting and fascinating that I placed an order with the publishers in England for all available back issues along with an annual subscription of the same.

Since then, I became an avid reader and collector of this superb magazine. Gradually, my fiercely guarded pile of Elektor Magazines grew up to great proportions. Later on, I switched over to the Indian edition as it was cheaper compared to the UK edition though the contents lagged behind by a month which really did not matter. Lately, I discovered that no one had posted any issues of Elektor Magazine prior to the year 1990. I therefore found myself in a unique position to fill the gap and to help collectors of this magazine by scanning and posting my vintage collection on the internet. I toyed with the idea for a very long time until my enthusiasm overcame my laziness. I went out and bought a portable scanner just for this purpose. I have scanned and posted over 125 issues from my vintage collection over the last few months. At 65, with bad eyes and poor health my enthusiasm is wearing out. I, therefore, seek your pardon for the long intervals between my postings.

I have been informed that sadly, someone is trying to sell my scanned vintage issues of Elektor magazines on e-Bay. I was sure that sooner or later someone would try to make money out my efforts. However, it does not make me angry but it certainly make me sad. For me it has been purely a labour of love without any commercial value whatsoever. I wish it had remained free for all to share as intended. Alas, greed takes out all the fun from sharing. I thank all of you for the great encouragement in my venture.

A Merry Christmas & A Very Happy New Year to all of you.



youareabuddha@gmail.com

December 13, 2010

SAVE ON AMPLIFIERS

SAVE A LOT BY MAKING PRE-AMPLIFIER & POWER AMPLIFIER YOURSELF WITH "VISHA KITS"

PRE-AMPLIFIERS

Guitar Mixer

Usable with our 100 Watt Guitar Amp. & also with other Amplifiers
Kit for Rs. 75/-.

Austereo Control

Transistorised pre-amp. having high input imp. & low output imp.
Kit for Rs. 120/-.

Philips Universal

Transistorised Universal pre-amp. can match 5 different inputs dynamic P.U., Crystal P.U., Radio, Tape Recorder & Microphone.
Kit for Rs. 100/-.

Consonant.

High quality Rumble, Scratch filters & tone controls.
Kit for Rs. 350/-.

Stereo Cassette pre-amp.

Using IC 741. Can be matched with any normal stereo cassette head.
Kit for Rs. 80/-.

General purpose (Stereo) pre-amp.

Uses IC LM 382 for magnetic pick-ups, tape head & microphone.
Kit for Rs. 60/-.

POWER-AMPLIFIERS

TBA 810 7 Watt.

Kit for Rs. 50/-.

TBA 810 7 Watt with passive tone & Power Supply.

Kit for Rs. 60/-.

TDA IC 1010-10 Watt. Amp.

Kit for Rs. 55/-.

Philips Hifi 25 Watt.

High fidelity Amplifier
Kit for Rs. 150/-.

Philips Hifi 15 Watt.

High fidelity Amplifier
Kit for Rs. 135/-.

STK-077/STK-078-30W Amp.

Kit for Rs. 400/-.

STK-439 Hifi Stereo-30W + 30W Amp.

Compact unconditionally stable Amplifier.
Kit for Rs. 700/-.

Philips Hifi-40W.

High fidelity Amplifier
Kit for Rs. 170/-.

Edwin Amplifier 40 Watts.

Direct coupled Amplifier using class-A&B Stage to handle low and high signal levels
Kit for Rs. 200/-.

Elektronade (50w + 50w) Stereo.

High Quality Amplifier using IC LM 391. 2 Channels can be bridged to make a 100W. mono amp.
Kit for Rs. 380/-.

Equa Amplifier 100 Watt.

Can be used from 10W to 100W by using different values of supply voltage.
Kit for Rs. 230/-.

Guitar Amplifier 100 Watt.

High quality Hifi unit suitable for auditorium & public address systems.
Kit for Rs. 400/-.

* Rates for mono kits.

For stereo kits

rates are twice that of mono kits

Kits from Elektor issues

Aug/Sept. '86

Car Tape Radio Alarm Rs. 70/-

March 84

capacitance meter Rs. 700/-
(Range 0.1 pf to 20 mfd)

KIT FROM THIS ISSUE Sensitive lightmeter

Rs. 300/-

(Complete kit with Cabinet & meter)

Elektor projects — we stock most of the components.

VISHA
ELECTRONICS

17, Kalpana Building
349, Lamington Road,
BOMBAY-400 007.

Tele: 362650

"VISHA"

The One Stop Component Shop

TERMS:

- Goods by return post subject to availability.
- Special prices for volume order.
- Minimum outstation orders Rs. 50.00
- All orders must carry a minimum advance of .50%, balance payment by VPP or through Bank. (No cheque payment.)
- Prices are subject to change without any prior notice, will be charged as prevailing on date of despatch of goods.
- All prices are exclusive of M.S.T. and Postage.

Publisher: C.R. Chandarana
Editor: Surendra Iyer
Editorial Assistance: Ashok Dongre
General Manager: J. Dhas
Advertising: B.M. Mehta
Production: C.N. Mithagari

Address:

ELEKTOR ELECTRONICS PVT. LTD.
52, C Proctor Road
Bombay - 400 007 INDIA
Telex: (011) 76661 ELEK IN

Overseas editions:

Elektor Electronics
Standfast House
Bath Place
High Street, Barnet
Herts EN5 5XE U.K.
Editor: Len Seymour

Publitrón Publicações Técnicas Ltda
Av Ipiranga 1100, 9º andar
CEP 01040 Sao Paulo - Brazil
Editor: Juliano Barsali

Elektor sarl
Route Nationale; Le Seau; B.P. 53
59270 Bailleul - France
Editors: D R S Meyer;
G C P Raedersdorf

Elektor Verlag GmbH
Susterfeld-Straße 25
100 Aachen - West Germany
Editor: E J A Krempelsauer

Elektor EPE
Karaiskaki 14
16673 Voula - Athens - Greece
Editor: E Xanthoulis

Elektuur B.V.
Peter Treckpoelstraat 2-4
6191 VK Beek - the Netherlands
Editor: P E L Kersemakers

Ferreira & Bento Lda.
R.D. Estefânia, 32.1º
1000 Lisboa - Portugal
Editor: Jorge Goncalves

Ingelek S.A.
Av. Alfonso XIII, 141
Madrid 16 - Spain
Editor: A M Ferrer

In part:

Kedhorn Holdings PTY Ltd
Cnr Fox Valley Road &
Kiogle Street
Wahroonga NSW 2076 - Australia
Editor: Roger Harrison
Electronic Press AB
Box 63
182 11 Da. deryd - Sweden
Editor: Bill Cedrum

The Circuits are for domestic use only.
The submission of designs of articles of
Elektor India implies permission to the
publishers to alter and translate the text
and designed to use the contents in
other Elektor publications and activities.
The publishers cannot guarantee to
return any material submitted to them.
All drawings, photographs, printed
circuit boards and articles published in
Elektor India are copyright and may not
be reproduced or imitated in whole or
part without prior written permission of
the publishers.

Patent protection may exist in respect of
circuits, devices, components etc.
described in this magazine.

The publishers do not accept
responsibility for failing to identify such
patent or other protection.

Distributors:
Blaze Publishers & Distributors Pvt. Ltd

Printed At:
Trupti Offset
Bombay - 400 013
Ph. 4923261, 4921354



Copyright © 1986 Elektor B.V.
The Netherlands



Volume-4 Number 12
December - 1986

Electronics technology

Actuation system for flight control	12.26
Sound sampling and digital synthesis	12.36
The battle for supertelevision	12.44
Tell-tale magnetism of heart-throbs	12.47

Projects

Top-of-the-range preamplifier - Part 1	12.19
Indoor unit for Satellite TV reception-part-2	12.28
Sensitive light meter	12.41
RF circuit design	12.50

Information

News and views	12.15
New products	12.60
Licences & letters of intent	12.66
Switch board	12.71

Guide lines

Classified ads	12.74
Index of advertisers	12.74

Selex-18

Relays	12.52
Wire movement in a magnetic field	12.54
Bicycle dynamo	12.57

NOTE:

Computerscope-2 will be featured in one of our forthcoming issue and not in this issue as mentioned earlier.

FREE

**SEND COLOURFUL GREETINGS
TO YOUR FRIENDS.**

Simply detach the card in this issue, write your message,
affix appropriate stamps and mail them.

Quality & Creativity From:

LUXCO®

Range of 'TV' speakers

COLOR T.V. SPEAKERS			
TYPE/DIMENSION	M.M./INCHES	WATT	COMPATIBLE
8x13 LCT 3/5	78x118 (3 1/4"x4 1/4")	3W/5W	CONTEC/TOSHIBA
10x15LCT6-D	104x150 (4"x6")	6W	GRUNDIG/PHILLIPS
10 LCT 3	104x104 (4"x4")	3W	SONY/SHARP/I.V.C.
10 LCT 5	104x104 (4"x4")	5W	-Do-
9 LCT 3	90 (3 1/2")	3W	CONTEC/I.V.C.
9x5.5 LWCT2	90x55 (3 1/2"x2.6")	2W	TOSHIBA/CORE
B/W T.V. SPEAKERS			
8 LG 1/2	77 (3")	1W/2W	DAEWOO (14")
9 LG 2/3	90 (3 1/2")	2/3W	DO/CONTEC. (14")
10 LG 3/5	104 (4")	3/5W	SONY/GOLDSTAR (20")
7x10 LG 2	65x103 (2 1/2"x4")	2W	(14")
8x13.LG 3/5	78x118 (3 1/4"x4 1/4")	3/5W	CONTEC/SOMPU (20")
10x15 LG 6	104x150 (4"x6")	6 W	PHILLIPS/NEL. (20")
TWEETER			
5 LT 5 *	50 (2")	5W	FOR COLOR. T.V.
5 LT 10**	50 (2")	10 W	FOR B/W T.V.
3 LT 10**	25 (1")	10 W	FOR COLOR T.V.
2 LTD 15	20 (3/4")	15 W	"
ILD 10	10 (1/2")	10 W	"

Tweeters And Flat Cone Woofers

- Manufactured by:
LUXCO Electronics
Allahabad—211 003
- Sole Selling Agents:
LUXMI & CO.
56, Jahnstonganj
Allahabad—211 003.
Phone. 54041, Telex. 540-286
- Distributors for Delhi & Haryana:
Railfon Electronics
Radio Place, ChandniChowk,
Delhi-110 006.
Phone: 239944, 233187.

□ Distributors for Maharashtra,
Gujarat and South India:

precious®
Electronics Corporation

- Chalani Building, 52, Proctor Road,
Grant Road (East), Bombay-400 007.
Phones: 367459, 369478
- 9, Athipalton, Street, Mount Road,
Madras—600 002. Phone: 842718.

sound technology from a sound source

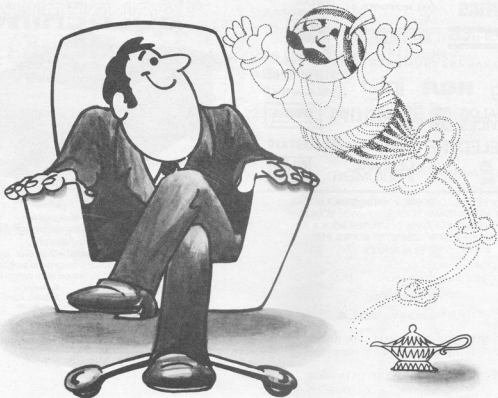

Get your international conference to take off with the right man behind you.

Air-India's Congresses & Conventions team. They work as one man to see your conference successfully through. By offering all their advice—absolutely free!

They work with you right from inception by helping you promote your conference. Advising you how to bid for India as your conference venue. Liaising with your delegates. And transporting them to India on a wide range of low, low group and individual fares.

Of course, they're backed by Air-India's worldwide network of 145 offices. So that your conference gets all the publicity and promotion it needs. And by Delhi's superb conference venues. Like the Talkatora Stadium

or the Indira Gandhi Stadium. Or, the many new hotels in Delhi, most of which offer excellent conference facilities. Or even the ultra-modern Sher-i-Kashmir International Conference Centre at Srinagar.

Attached to the superb 5-star Centaur Lake View Hotel next to Dal Lake.

Naturally, with such services, it's no surprise that Air-India has been closely involved with the 12th International Leprosy Congress, the World Energy Conference, the World Mining Conference and many more.

The next time you want to host an international conference, make sure you have the right sort of backing. Get in touch with:

Air-India
Congresses & Conventions
6th Floor, 'Vandhana'
11, Tolstoy Marg
NEW DELHI-110 001
Tel: 3311225
Cable: AIRINDIA



You host it. We'll help promote it.



Member
International Congress
& Convention Association

AIR-2310

**LOOKING FOR
OFF THE SHELF DELIVERY
WE ARE THERE TO SERVE YOU FOR.**

CDIL

HINDUSTAN[®]

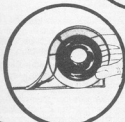
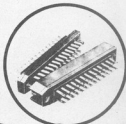
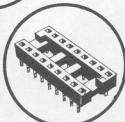
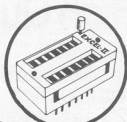
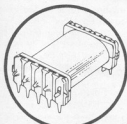

DELTA
Reed Relays &
Reed Switches

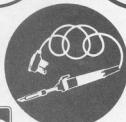

EXCEL
ZIF Socket

Champion
IC Sockets

ep
elcom
Components

YABASU
Drafting Aids

Diamond
Desoldering Pump

SOLDRON[®]
Soldering Irons



J.M. ENTERPRISES

382 LAJPAT RAI MARKET DELHI-110 006 PH- 235455, 238919

TOP-OF-THE-RANGE PRE-AMPLIFIER-Part 1

The accent throughout the design of this preamplifier has been on quality and the avoidance of unnecessary features, such as tone control and remote operation. It is not cheap to build: probably around £200-£250, but then, a commercial preamplifier of comparable quality is at least twice as expensive.

Hi-fi is probably the most misused term in the audio and music world. Properly used in connection with sound reproduction equipment it means that the equipment can produce sounds that are as nearly as possible a faithful reproduction of the original, and at a level that offers the listener almost the same amplitude as he would have obtained from the original source. The limitations of most sound reproduction equipment and the general acoustics of the room in which the equipment

operates prevent these conditions being satisfied in virtually all cases. Not much can generally be done about the room acoustics, but the equipment can be made as nearly perfect as modern technology allows.

Fortunately for the constructor, components get better all the time, and our knowledge of audio engineering progresses steadily. Today, there is a tremendous variety of sound reproduction equipment on the market at a price ratio of, perhaps, as high as

1:30. As far as the design of this equipment is concerned, it can be divided into roughly two categories: (1) that with an imposing appearance and a row of controls that is almost entirely dependent on price, and (2) that in which above all the quality of the reproduced sound has been considered. There are, of course, many variants in each of these categories, but the broad division is very pertinent. Music lovers and audiophiles, by definition, are only interested in category 2 equipment,

Fig. 1. Block diagram of the preamplifier.

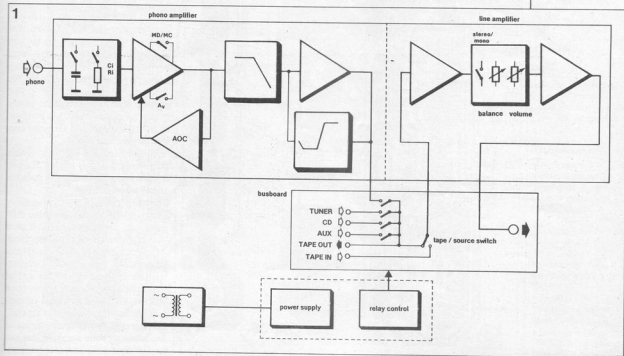

Fig. 2. The IEC recommended recording and playback characteristics.

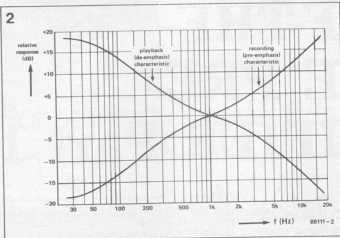
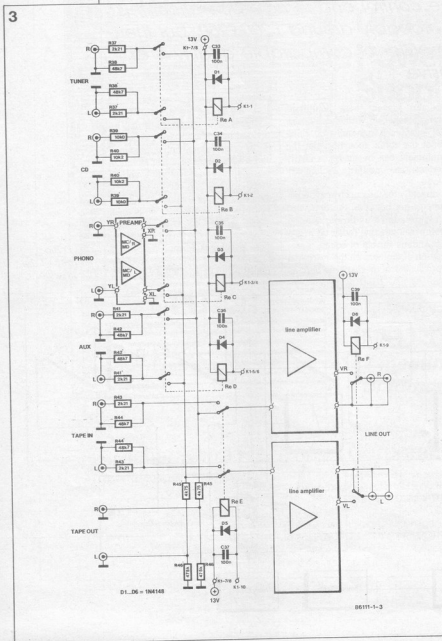

Fig. 3. Input and relay circuits.



because they know that it pays to invest in high-quality sound processing rather than in a range of interesting, but strictly unnecessary, facilities, such as complex tone controls and remote operation. After all, audio equipment is all about reproducing music to as faithful an original quality as possible.

As stated, category 2 can be subdivided into a number of variants. The remarkable observation that can be made here is that there is a certain connection between the price and the number of operating controls. As the quality and, subsequently, the price rise, the number of controls decreases. This is not always strictly true, but there is a definite trend.

At the top, there is equipment designed by and for purists from which anything that has no direct bearing on the sound quality has been omitted. Such equipment is geared to the utmost perfection of the reproduced sound. Often, the preamplifiers of this kind of equipment have only an on-off switch, input selector, and volume control. The preamplifier proposed here belongs to this class of equipment, although it has three more controls than mentioned: mono-stereo; tape-source; and balance.

Basic layout

The block diagram in Fig. 1 shows the layout of the preamplifier. Each of the three sections in dashed lines is located on a separate printed-circuit board. That at the top is the preamplifier proper, which is, of course, a stereo set-up, although only one channel has been shown. The section underneath it is the busboard which contains the input and output connectors, the various selectors, and associated parts. The third board contains the power supply, with the exception of the mains transformer which is mounted in a separate box, and the relay control circuits.

The relay control circuits enable selection of various modes of operation to be made as close as possible to the relevant input.

The preamplifier is almost entirely DC-coupled: where this proved difficult or impossible, high-quality polypropylene capacitors are used, which obviate the usual drawbacks of capacitor coupling. The characteristics of these capacitors and of the special semiconductors used will be discussed in detail in next month's continuation of this article.

The preamplifier proper consists of two parts: a phono amplifier that can be fed from either an MC (moving-

coil) or an MD (magneto-dynamic) cartridge, and a line amplifier with inputs for TUNER, CD (compact disc), AUX, and TAPE. The phono section is rather special, because it is not the usual combination of MD preamplifier and MC pre-amplifier, but a single stage whose amplification can be set to suit both MC and MD cartridges. The input stage of the phono amplifier offers the facility of terminating the pick-up cartridge used into the

correct capacitance and resistance: an indispensable feature in this class of amplifier.

The voltage gain, A_v , of the second stage can be arranged not only to accommodate either an MC or an MD element, but also—in two steps—to suit the output voltage of these elements. The active off-set correction—AOC—stage ensures that the off-set voltage at the output of the linear amplifier remains negligible small at all times without the need of

any adjustments.

The final stage in this section provides the necessary de-emphasis for record reproduction. The de-emphasis characteristic is within 0.1 dB of the relevant requirements of the IEC (International Electrotechnical Commission); the corresponding pre-emphasis characteristic—see Fig. 2—has been adopted by all major broadcasting organizations, virtually the whole of the recording industry in the western

Fig. 4. The busboard.

Parts list (Fig. 4)

Note. Starting with the preamplifier, parts lists will in future be published in full accordance with BS 1852; hitherto, these lists deviated from that standard in some respects. See infocard opposite inside back cover.

Resistors (all metal film):

R37; R37'; R41; R41'; R43;
R43' = 2K21F
R38; R38'; R42; R42'; R44;
R44' = 48K7F
R39; R39' = 10K0F
R40; R40' = 10K2F
R45; R45' = 4K75F
R46; R46' = 475KF

Capacitors:

C33; C34; C35; C36; C37;
C29 = 100nM ceramic

Semiconductors:

D1; D2; D3; D4; D5;
D6 = 1N4148

Relays:

ReA; ReB; ReC; ReD; ReE;
ReF = sub-miniature/
PCB mounting relay
two-pole change-over;
12 V*

Miscellaneous:

K1 = 10-way PCB
mounted socket**
16 screened phono
chassis sockets with
mating plugs**

*Available from
Electromail • P O Box
33 • Corby •
Northants NN17 9EL •
Telephone: (0536)
204555

**Available from
Verospeed • Standsted
Road • Boyatt Wood
• Eastleigh • Hants
SO5 4ZY • Telephone:
(0703) 644555

4

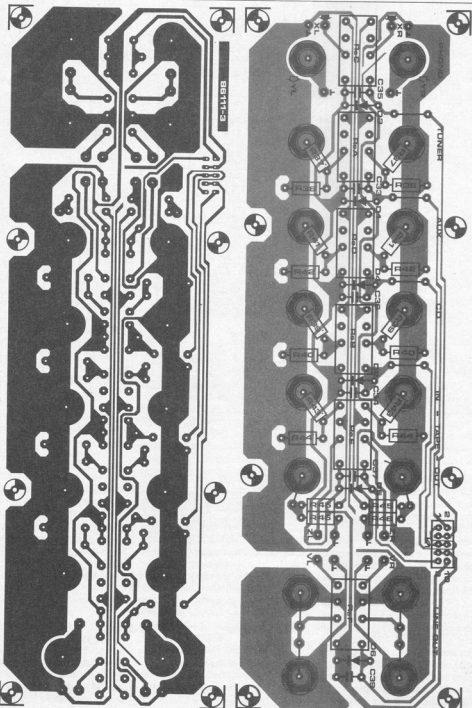
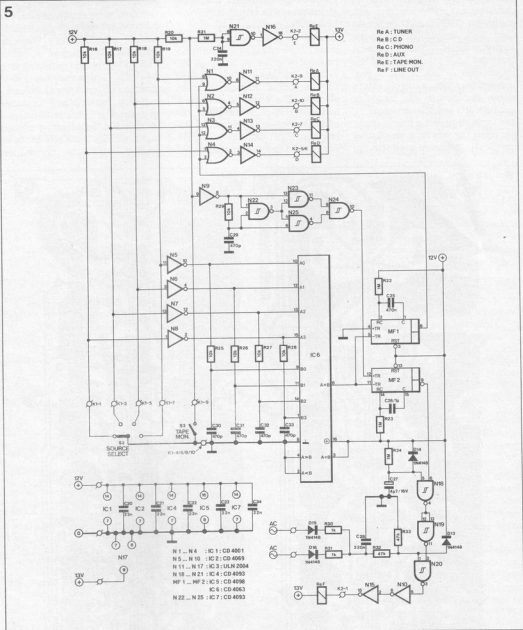

Fig. 5. The relay control circuits.



world, and such organizations as the AES (Audio Engineering Society), the RIAA (Record Industry Association of America), and the NARTB (National Association of Radio and Television Broadcasters).

The linear line amplifier contains the volume as well as the balance control, and also the stereo-mono selection facility.

Busboard

The busboard contains not only all input and output connectors and relays, but also the voltage dividers required for level matching. Its circuit diagram is shown in Fig. 3. At the left are all the inputs, and at the

right all the outputs. The relays (with associated capacitors and free-wheeling diodes) take care of all the switching.

Since a compact disc player provides a much higher output voltage than, say, a tuner or a tape recorder, the CD input is attenuated by voltage divider R₃₉-R₄₀ (R₃₉-R₄₀). The voltage dividers on the other inputs serve merely to reduce near-end crosstalk even further and are, strictly speaking, not necessary. Inputs not in use are taken to ground via resistors R₃₈, R₄₀, R₄₂, and R₄₄ (R₃₈, R₄₀, R₄₂, and R₄₄).

The relays are controlled from the relay control section on the power supply board.

The busboard—see Fig. 4—has been

designed in a way that facilitates its direct mounting onto (screened) phono sockets.

The relays are miniature PCB types which must be of the best quality to ensure that no unnecessary resistances are introduced in the (low-level) signal paths. It is recommended to use phono connectors and relays with gold-plated contacts if at all possible.

Relay control

The relays on the busboard are controlled by a number of driver stages on the supply board, which have been designed to ensure virtually noiseless switching operation. The

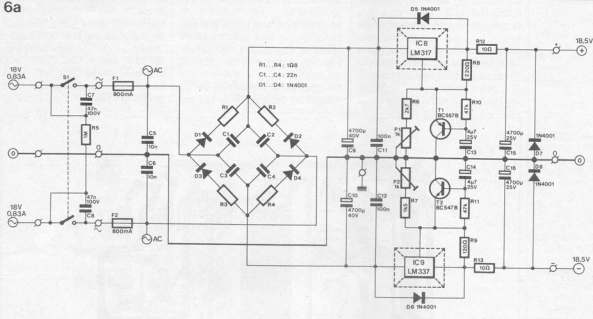

circuit diagram of the relay control section is shown in Fig. 5.

When the supply is first switched on, the output relay is energized after a slight delay; when the supply is switched off, however, the output relay is deactivated immediately.

Source selection

When either the input selector or the tape-monitor switch is operated, the output relay is de-energized before the relevant change is effected, and reactivated only after the new input or tape position has been selected.

The non-used contacts of the source selector, S_2 , are logic high via resistors R_{16} to R_{19} incl., while the selected input contact is logic low via the switch wiper. The switching arrangement is passed on to inputs A_0 to A_3 of comparator ICs, where it is compared (nibble) with the situation at pins B_0 to B_3 . Because of the time delay introduced by R_{29} - C_{30} ; R_{28} - C_{31} ; R_{27} - C_{32} ; and R_{28} - C_{13} respectively, the two compared nibbles will differ by a few microseconds. This will cause the output (pin 6) of ICs momentarily to go low when S_2 is turned. This negative pulse triggers monostables MMV_1 and MMV_2 , which introduce delays of 0.5 s and 1 s respectively. If both are triggered simultaneously, the selected input and the line out relay, Rel , are disconnected instantaneously by N_1 , N_2 , N_3 , or N_4 and N_{18} - N_{20} - N_{10} - N_{15} respectively. After the delay caused by MMV_1 has lapsed, the newly selected input is connected, and after the delay caused by MMV_2 has lapsed, the line out relay is re-energized.

b

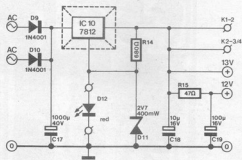

Tape monitor

When tape monitor switch S_3 is closed, a positive pulse is generated with the aid of N_9 , delay network R_{23} - C_{28} , and XOR gate N_{22} - N_{23} - N_{24} - N_{25} . This pulse triggers MMV_2 so that line out relay Rel is deactivated. After a delay R_{31} - C_{34} , tape monitor relay Rel is energized. The line out relay is re-energized when the delay introduced by MMV_2 has lapsed.

It is important to note that during the above operation the input relays remain energized, and the connection with tape out is not broken.

Power on

The line out relay is energized after a delay R_{24} - C_{27} . This time constant is just a little longer than the time required by the power supply to attain full output. Diode D_{14} ensures a rapid discharge of C_{27} when the power is switched off.

Power failure

The secondary voltage of the mains

transformer is rectified by D_{15} and D_{16} and smoothed to some extent by C_{28} . It is then roughly halved by voltage divider R_{32} - R_{33} to provide a suitable input (<12 V) to pin 1 of N_{20} . Diode D_{13} affords protection against noise peaks. Because of the very short time constant R_{32} - R_{33} - C_{28} (about 20 ms), the line out relay is de-energized the instant the power is switched off or fails.

Power supply

The power supply is rather more extensive than is usual with this type of equipment: this is because of the requirement for different voltages for the audio sections, the relays, and the relay control.

The supply for the audio section—see Fig. 6a—provides a symmetrical voltage of ± 18.5 V. Everything feasible has been done to reduce hum and other noise to a minimum, and the circuit therefore contains components not often found in power supplies.

The mains transformer should have

Fig. 6a. Power supply for the audio section.

Fig. 6b. Power supply for the relays and relay control circuits.

two secondary windings, each providing 18 V at 1 A. The ILP Type 11014 is perfect. The transformer is not housed in the preamplifier enclosure but in a separate box; this is again to reduce hum in the preamplifier to an absolute minimum. The mains on-off switch, S_1 , is de-bounced by C_7 and C_8 ; noise peaks

on the mains are shorted to ground by C_5 and C_6 .

Resistors R_1 to R_4 in series with rectifiers D_1 to D_4 limit current peaks at switch-on. Capacitors C_1 to C_4 effectively suppress the internal noise of the rectifiers.

Reservoir capacitors C_9 and C_{10} are shunted by foil capacitors C_{11} and

C_{12} to improve the suppression of RF noise.

Stabilization of the ± 18 V lines is effected by IC_8 and IC_9 . The action of these regulators is enhanced by transistors T_1 and T_2 , which act as variable zener diodes: presets P_1 and P_2 enable the output voltage to be set to the precise level.

Fig. 7. Printed-circuit board for the power supplies and relay control circuits.

Note. Starting with the pre-amplifier, parts lists will in future be published in full accordance with BS 1852; hitherto, these lists deviated from that standard in some respects. See in-focord opposite inside back cover.

Parts list (Fig. 7)

Resistors:

$R_1, R_2, R_3, R_4 = 1R8$
 $R_5, R_{21}, R_{22}, R_{23}, R_{24} = 1M0$
 $R_6 = 2K7$
 $R_7 = 1K5$
 $R_8 = 220R$
 $R_9 = 120R$
 $R_{10}, R_{11}, R_{32}, R_{33} = 47K$
 $R_{12}, R_{13} = 10R$
 $R_{14} = 680R$
 $R_{15} = 47R$
 $R_{16}, R_{17}, R_{18}, R_{19}, R_{20}, R_{25}, R_{26}, R_{27}, R_{28}, R_{29} = 10K$
 $R_{30}, R_{31} = 1K0$
 $P_1, P_2 = 1K$ preset

Capacitors:

$C_1, C_2, C_3, C_4 = 22n$;
 250 V; MKT
 $C_5, C_6 = 10n$; 250 V;
 MKT
 $C_7, C_8 = 47n$; 250 V;
 MKT
 $C_9, C_{10} = 4700\mu$; 40 V;
 electrolytic
 $C_{11}, C_{12} = 100n$
 $C_{13}, C_{14} = 4\mu 7$, 25 V;
 electrolytic
 $C_{15}, C_{16} = 4700\mu$; 25 V;
 electrolytic
 $C_{17} = 1000\mu$; 40 V;
 electrolytic
 $C_{18} = 10\mu$; 16 V;
 electrolytic
 $C_{19} = 100\mu$; 16 V;
 electrolytic
 $C_{20}, C_{21}, C_{22}, C_{23}, C_{24} = 22n$

7

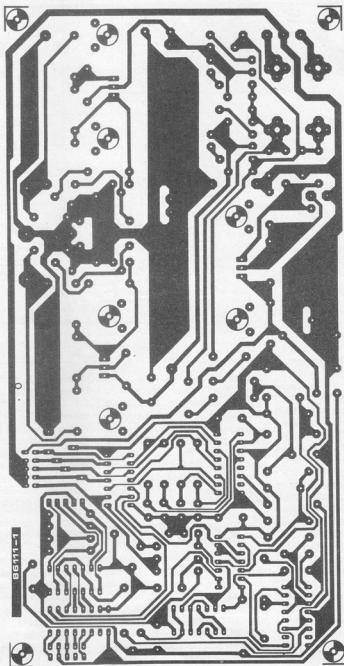

Networks R₁₂-C₁₅ and R₁₇-C₁₆ are low-pass filters with a very low cut-off frequency which ensure the virtually complete elimination of any noise from the supply lines.

The supply for the relays and the relay control circuits—see Fig. 6b—is fairly simple. The output voltage of regulator IC₁₀ is increased some-

what by connecting the ground pin to earth via diode D₁₂. This LED also functions as the on-off indicator.

Zener diode D₁₁ is a safety precaution that ensures correct operation if for some reason the LED breaks down.

The printed-circuit board for the power supply and the relay control

circuits is shown in Fig. 7. Note that voltage regulators IC₆, IC₉, and IC₁₀ must be mounted on a suitable heat sink.

This article will be continued in our January 1987 issue.

C₂₄; C₂₆ = 220n
 C₂₅; C₂₈; C₃₀; C₃₁; C₃₂ = 470p
 C₂₆ = 1µ0
 C₂₇ = 4µ7; 16 V;
 electrolytic
 Semiconductors:
 D₁; D₂; D₃; D₄; D₅; D₆; D₇;
 D₈; D₉; D₁₀ = 1N4001
 D₁₁ = zener 2V7;
 400 mW
 D₁₂ = LED red
 D₁₃; D₁₄; D₁₅; D₁₆ = 1N4148
 IC₁ = CD4001
 IC₂ = CD4069
 IC₃ = ULN2004
 IC₄; IC₇ = 4093
 IC₅ = 4098
 IC₆ = 4063
 IC₈ = LM317
 IC₉ = LM337
 IC₁₀ = 7812

Miscellaneous:

S₁ = switch; 2 × make
 S₂ = switch; rotary;
 1-pole 4-way
 S₃ = switch; 1 × make
 delayed action
 2 fuseholders
 mains transformer
 2 × 18V; 0.83 A; e.g.
 ILP Type 11014**
 3 heat sinks; 6.8 K/W;
 e.g. Fischer
 SK59-37.5*
 K₁; K₂ = 10-way PCB
 connector (header)
 PCB 86111-1

** Available from:
 Jaytee Electronics
 Services; telephone
 (0227) 375254

* Available from
 DAU (UK) Limited;
 telephone (0243)
 553031

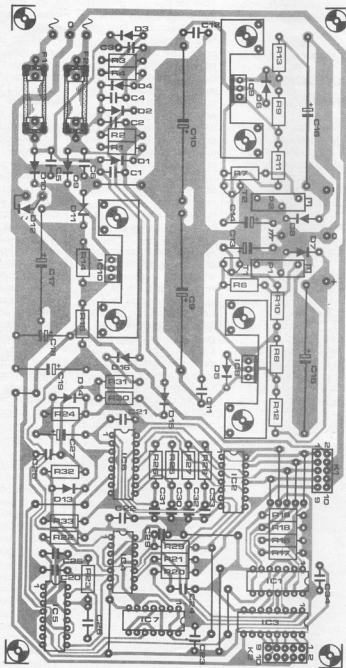

ACTUATION SYSTEMS FOR FLIGHT CONTROL

by A W Pressdee, BSc, CEng, MIEE

The need to transmit control of an aircraft from the pilot's hands to the flight control surfaces has always existed. In early aircraft, this was achieved by rudimentary linkages consisting of rods and cables, but as speeds increased it became necessary to boost the pilot's muscular effort by the introduction of hydraulic systems. These were effectively fluid rods: the fluid being, to all intents and purposes, incompressible. When such systems were introduced just before World War II, it was felt that hydraulic actuators enjoyed many advantages over the electromechanical kind in terms of reliability and the high torque and power they could provide. Consequently they became recognized in the ensuing 20 to 30 years as the preferred method for all high power demand applications. Hydraulic systems were used to control and operate flaps and slats, tailplanes, elevators, ailerons, rudder surfaces, and various engine functions. In the interests of safety, such systems incorporated a high degree of redundancy, and with it, an increased weight penalty. Hydraulic systems were designed on the assumption that not more than a proportion in the region of two-thirds of the actuators would operate simultaneously. Over the last decade or so, new approaches to aerodynamics have brought with them different control philosophies with new acronyms to identify them. These approaches are referred to generally by the title control configured vehicles (CCV), in which means are employed, such as fuel redistribution, to set up a state of relaxed or even

negative stability in the aircraft's pitch axis. It results, for example, in the case of combat aircraft, in a decrease in manoeuvring inertia and enhanced control response.

Electromechanical actuators

To achieve this, a computer is interposed between the pilot and the surface controlled to ensure the basically unstable aircraft obeys the control inputs. The control commands now take the form of digital electrical signals, and such systems are known as fly by wire (FBW). Not surprisingly, the most recent manifestation of this type of system, which employs fibre optics in place of electrical conductors, is called fly by light (FBL). The next step towards that design concept, which has been on aircraft manufacturers' drawing boards for some time, the all electric aircraft (AEA), involves the replacement

of the existing hydro-mechanical units with electromechanical actuators (EMA). In the past, the high weight of available motors and an inadequate reliability level have precluded their use. New types of motor becoming available for power by wire (PBW), as it is called, have power to weight ratios and reliability levels high enough to permit their use on both military and civil aircraft. The great advantage of the electrical motor, compared with the hydraulic actuator, is that its rotational output enables it to transmit torque direct about the hinge line of the control surface. An additional advantage of the new dc motors, which use magnets of rare earth alloys such as samarium cobalt and neodymium iron, is that they can tolerate high peak overloads for short periods. Their use in a PBW control system is said to save hundreds of kilograms in the overall weight of a transport aircraft compared with a hydraulic system. It should

be noted, however, that for optimum motor design a voltage higher than the standard 28 V aircraft supply is necessary. At the forefront of actuator development is Lucas Aerospace¹¹, a member of the 65 000 strong group, Lucas Industries, based in Wolverhampton. The company in fact first introduced FBW in the early 1960s for the TSR2 aircraft and development has progressed apace since then. The development and manufacturing divisions of Lucas Aerospace encompass a wide range of aircraft products including flight and engine control systems; electrical power, nacelles and thrust reverser systems; missile and auxiliary power systems; metal and composite fabrication; fuel system equipment and cryogenics; aircraft transparencies; electroluminescent lighting (EL) and Sparymat ice protection; starting and electrical distribution; mechanical equipment; Hi-Re1 hybrid microcircuits; software and combustion technology.



British Aerospace Canard control system for the Penguin Mk 3 missile produced by Kongsberg Vapenfabrikk.

What is made

The products of the Actuation Division cover powered flying control systems; flap and slat actuation and control systems; electro-hydraulic servo actuators; hydraulic piston and ball screw actuators; tailplane actuator units; electro-hydraulic multiplex actuators (FBW); geared rotary actuators; ram-jet fuel controls; fuel flow equalizers; variable feed systems; electro-hydraulic power packs; wheel brake pressure control systems; hydraulic and pneumatic engine thrust reverser actuation and control

systems; hydraulic and pneumatic engine nozzle actuation and control systems; and helicopter gun turrets.

Since 1946, Lucas Aerospace has designed flap and slat operating systems for 14 different aircraft types. Of these, the progression in development of actuation systems may best be illustrated by consideration of the actuation system for Airbus Industrie aircraft produced by Lucas Aerospace in conjunction with Liebherr Aero Technik.

The Airbus A300 and A310 have the most modern design of ballscrew actuator for both flap and slat layouts. The control unit in each system has differentially coupled hydraulic motors with pressure off brakes and transmission shafting of stainless steel tubing. Both flap and slat systems on the A300 have six actuators per wing, the flap system having torque limiters between control unit and the inboard actuators as well as jackhead torque limiters. On the Airbus A310, the control of flap (four per wing) and slat actuators is FBW using microprocessors. As well as transmitting the input command signals, this ensures continuous monitoring. Any malfunction such as asymmetry or uncommanded movement is detected and made safe. In the Airbus A320 system under development, rotary actuators incorporating the latest in gear design form the final drive elements and take the design progression one stage further. This type of rotary actuator is compact and may be driven via transmission shafting or individual rare earth electrical motors. Apart from development for Airbus Industrie, which also includes aileron, elevator and spoiler actuators, Lucas Aerospace is engaged on design and supply of a complete leading edge flap control system for the SAAB JAS-39

fighter, and is participating in the design and supply of the complete thrust reverser actuation systems for General Electric CFM-56-5 and International Aero Engine V2500 engines.

Guided weapons

The design requirements for guided weapon actuator systems present the designer with a different form of challenge. Complete reliability is needed only for a matter of minutes before the system destructs but in those minutes the control and actuator system is exercised to a maximum. The range of control and actuation systems used in guided weapons embraces a wide variety of types including electrical, hydraulic, hot and cold gas aerodynamic actuators, together with various systems using thrust vector control. The Electronic Systems and Equipment Division of British Aerospace² is one of the few specialist companies in the world undertaking the design and development of such systems, and it is engaged as well on equipment such as autopilots and navigational devices using laser and miniature gyro components. Formerly the Sperry Gyroscope Company, the division, with over 30 years of experience in the guided weapons industry, has played a vital role in the development of systems for weapons such as Sea Slug, Sea Dart, Sting Ray, and Polaris. The four fin actuation system used on Sea Dart missiles is controlled by a two-stage analogue servo. The actuators for this produce output torques of 62 Nm with slow rates up to 1800 degrees/sec and provide a positional accuracy of 0.1 degree. The hydraulic pressure is generated by a hot-gas

motor pump which is driven by the product gases from an isopropyl nitrate (IPN) monopropellant gas.

One application for samarium cobalt permanent magnet dc servo motors is in a thermoplastics actuator package. This has been developed for mass production of low cost missile actuators which have a significant weight reduction and are ideally suited for lower performance weapons. A power output in excess of 30 Nm at 130 degree/sec is achieved.

Recent orders

Various types of thrust vector control (TVC) are being developed in conjunction with rocket motor manufacturers to greatly improve the agility of guided weapons. These range from swivelling nozzle TVC systems to spoiler or vane type systems which offer alternative ways of vectoring the rocket motor thrust. New developments are currently in hand that integrate a range of actuation and TVC systems in multimode to drive the control surface and TVC mechanisms of the future. The combined TVC and linked fin system will enable maximum manoeuvrability by using TVC after launch and subsequent fin control when the motor has burnt out. Recent orders include the design and production of an electrohydraulic power supply for the Aspide multi-role missile manufactured by Selena for the Italian Air Force and used as a primary air-to-air for the F104S interceptor. There is too an initial one for Canard actuation units (CAU) for the Penguin Mk 3 air-to-surface anti-ship missile, with orders for further units expected over the next ten years. The Penguin Mk 3, which is manufactured by

Kongsberg Vapenfabrikk of Norway for the Royal Norwegian Navy, is a follow-on from the successful Penguin Mk 2 ship launched missile, which is in service with several navies.

Lucas Aerospace not only makes fin control actuators for missile systems but also gas turbine propulsion systems. Its participation in major advanced missile programmes includes Harpoon, HARM, AMRAAM, Sea Skua, Sea Eagle, and Alarm. For the Alarm programme, the company is supplying the complete actuation system of the missile including electric servo actuators, control monitoring and data bus interface electronics, thermal battery, fin locks, and external casework.

1. Lucas Aerospace Ltd, Actuation Division, Stafford Road, Fordhouses, Wolverhampton, WV10 7EH.
2. British Aerospace PLC, Electronics Systems & Equipment Division, Downshire Way, Bracknell, Berkshire, RG12 1GL.

INDOOR UNIT FOR SATELLITE TV RECEPTION - 2

by J &
R v Terborgh

Following last month's description of the RF board in the IDU, this article focuses on the complementary functions including baseband filtering, audio & vision processing, and the power supply. With the present board added to the RF unit, and both mounted into a neat looking enclosure, you already have a complete set-top indoor tuner, although there are still a few optional extras in the pipeline.

In conclusion of this article a well-detailed alignment procedure is given, which can be carried out by anyone with only limited experience in electronics construction. Moreover, no special measuring equipment is called for, so let's get started again!

Block diagram

Fig.10 shows that the baseband signal from the RF board is passed through an R-L-C de-emphasis section before the 0-5 MHz part of the spectrum is subsequently amplified, clamped, and output; it is both

AC and DC-coupled as a CVBS (composite video — blanking — synchronization) signal by two buffer stages. The anti-dispersal function of the clamp stage will be reverted to. The sound subcarrier part of the baseband spectrum is fed to an amplifier via an L-C high pass section dimensioned for a cut-off frequency of about 5 MHz.

Any strong enough sound subcarrier can be extracted from the baseband spectrum by up-mixing it to a fixed, 280 kHz wide, intermediate frequency of 10.7 MHz, at which FM detection takes place. The IF signal is obtained by mixing the subcarrier frequency, f_{sc} , with the output of a tuneable oscillator, according to $f_{\text{osc}} = f_{\text{sc}} + 10.7 \text{ MHz}$.

An on-board power supply (PSU) powers all circuitry in the indoor tuner, as well as the download-fed LNB. Provision has been made for the incorporation of a visible and audible LNB theft alarm, which will be detailed next time.

Finally, the PLL S-meter signal is amplified to enable the driving of a small, front-panel mounted, relative signal strength meter.

Circuit description

With reference to Fig.11, the de-emphasis filter at the input of ICs has been dimensioned to recommen-

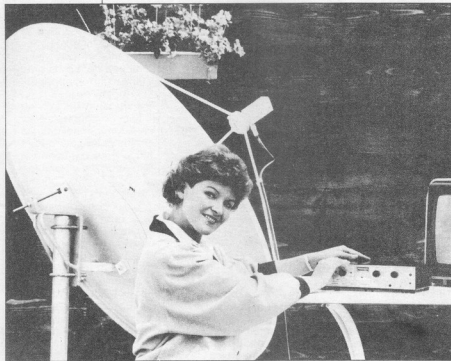

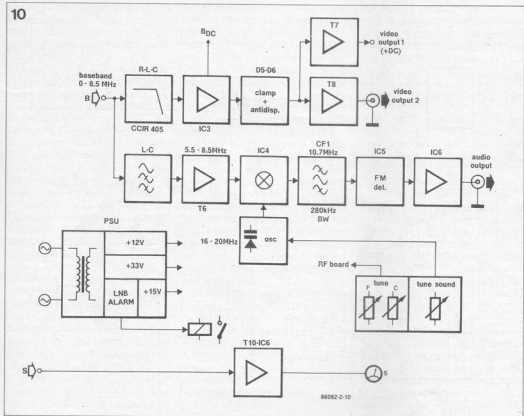

Fig. 10 Block diagram of the second board in the indoor tuner. Although this shows quite a number of stages, relatively few of these do the necessary work.

ation CCIR 405-1 (see Tables 2a and 2b in *Satellite TV reception*, *Elektron India*, October 1986).

Fig. 12 shows that the proposed version of the filter offers acceptable performance as compared with the requisite (theoretical) de-emphasis curve. The reason for the slight deviation lies in the practical component values, which have been selected as reasonable approximations of the results of the inset design equations. Termination and source impedance of the practical filter is 75 ohms.

Note that the baseband signal is direct-coupled right up to the differential inputs of IC₃; this arrangement enables decoupling capacitor C₅₆ to rapidly provide IC₃ with the correct bias voltage at power-on, ensuring instantaneous availability of audio and composite video at the tuner outputs.

A baseband DC (BDC) output terminal has been included to drive the optional AFC (automatic frequency correction) circuit, which will be detailed in Part 3 to be published in the February 1987 issue of *Elektron India*. P₁ is used to set the gain of fast differential amplifier IC₁.

The capacitively output CVBS signal is superimposed onto a reference level of V₀₅-0.7 = 5.5 V to enable output CVBS-1 to be at a relatively high DC level, which is useful if more emitter followers are to be driven (video distribution amplifier,

CVBS monitors, etc.). When the voltage at pin 8 of IC₃ falls below the reference, C₅₃ is charged with the voltage difference, which is retained until the chip output exceeds the reference again; then the capacitor's charge increases the instantaneous level of IC₃'s output voltage by vector addition (since they are not in phase). In this fashion, the lowest level of the CVBS signal, i.e. the sync-pulse bottoms, is clamped at 5.5 V, provided the period of C₅₃ and the buffer stages' input impedance is long relative to the period of any component in the 50 Hz - 4.5 MHz CVBS spectrum. This condition has been exploited for the removing of the dispersal component from the amplified video spectrum.

It would be beyond the scope of this article to enter into details regarding this method of avoiding cross-interference with terrestrial microwave links operating in the 11-13 GHz band. Briefly, the satellite's carrier is swept over 2-4 MHz_{RF} (see Tables 2a & 2b in *Satellite TV reception*, *Elektron India*, October 1986) by adding a 25 Hz component to the up-link CVBS signal. The triangular wave has a fixed phase relation to the 50 Hz field sync-pulse and causes the received picture to flicker if it is not removed by filtering. The previously mentioned period has been dimensioned to do just that, and the result is a stable picture from

all transponders employing dispersal.

A simple T-filter composed of C₄₆, L₁₃ and C₄₇ suppresses baseband signals below some 5 MHz ($f_c = 1/[2\pi\sqrt{2LC}]$) and at the same time provides some matching to the base of the oscillator transistors in IC₄.

The up-converted 10.7 MHz IF signal is next coupled out via L₁₆ and band transformer L₁₄.

IC₄ has been configured to offer optimum performance of the contained symmetrical mixer. The SO42P also has an on-chip oscillator which can be tuned over 16-20 MHz in the proposed design. Tuning is accomplished by applying an adjustable (P₂) voltage to varactor D₇, which, together with L₁₅-C₅₈-C₅₁, forms the external tuned circuit for the oscillator transistors in IC₄.

The up-converted 10.7 MHz IF signal is next coupled out via L₁₆ and passed through a matched ceramic filter providing a bandwidth of about 280 kHz.

IC₅ is the well-known Type TBA120S quadrature FM detector connected in a conventional arrangement which includes de-emphasis capacitor C₆₇. The AF output signal is buffered by A₂, and the output volume may be set as required by P₃.

The S-meter driver is basically an inverting voltage-to-current converter; the lower the direct voltage at the base of T₁₉, the more current will flow through the meter coil, whose

The CCIR-Comité Consultatif International de Radio* forms part of the International Telecommunications Union-ITU, which is a UN Specialized Agency with headquarters at the Place des Nations, Geneva. Through the CCIR, the ITU sets up international regulations for radio and TV services; allocates the radio frequency spectrum and registers all radio frequency assignments. It also studies, recommends, collects, and publishes information on all telecommunication matters, including space radio and TV communications.

* In English: *International Radio Consultative Committee*.

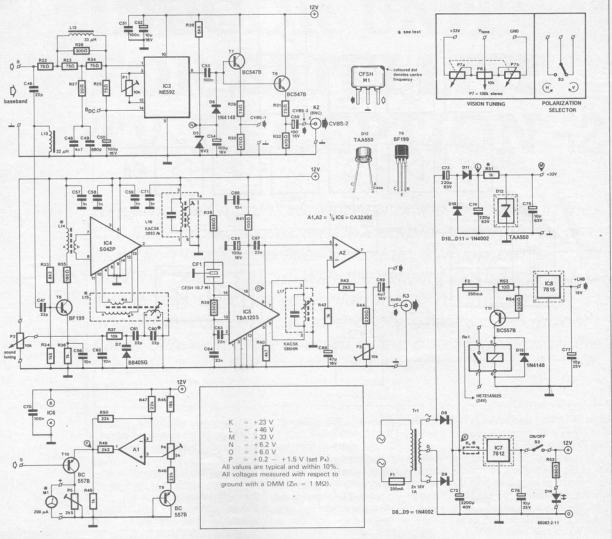

Fig. 11. Circuit diagram of the vision and sound processing stages, S-meter driver, and the combined power supply/LNB theft alarm. The dots at certain connections of L_{15} denote the starting points of coupled windings.

sensitivity can be accommodated by setting shunt preset P_4 . P_4 determines the stabilized emitter voltage of T_{10} and thereby the threshold below which the voltage at the S input must fall for minimum visible meter deflection.

Any type of small, rectangular moving coil meter will work fine in this circuit, provided the f.s.d current lies in the $100 \mu\text{A} - 1 \text{ mA}$ range. As the indication is merely relative, the meter need not have a specific scale division.

The power supply for the indoor tuner is of conventional design incorporating an LNB alarm relay driver, T_{11} , and a voltage doubler section $C_{73}-D_{19}-D_{11}-C_{74}$ which provides the raw input for 33 V stabilizer D_{12} . Some care should be taken in the dimensioning of R_{51} , as the temperature-compensated zener-diode should not dissipate too much power in the case of a fairly high transformer secondary voltage, U_{T11} . The value of R_{51} is calculated from

$$R_{51} \approx (2.5U_{T11} - 0.6 - U_z) / I_z \quad [\Omega]$$

where U_z and I_z are the zener voltage and current respectively. The stated value of R_{51} gives a zener current of about 13 mA with a loaded transformer output of $18 V_{\text{rms}}$. Obviously the resulting dissipation of about 430 mW requires the TO18 case of D_{12} to be fitted with a small heatsink.

Constructors should note that the Type TAA550 has a production tolerance of 10%; therefore its zener voltage may lie between about 30 and 36 V. $I_{z(\text{max})}$ of the device is stated as 20 mA by its manufacturer, SGS.

Experiments have shown that the Type ZTK33 can also be used for D_{12} , provided R_{51} is redimensioned for $I_{z(\text{max})}$ of 7 mA.

The LNB alarm relay is de-energized, and its contacts are opened, when the voltage across current sense resistor R_{53} drops below about 0.7 V, as is the case when the LNB is discon-

nected. The relay contacts will also open when the download cable is short-circuited, e.g. by cutting, as F_2 blows which de-energizes the relay coil. The relay contacts may be wired to an existing alarm circuit.

Finally, inset are the fine & coarse tuning controls and polarization selector S_1 , which is shown unconnected as there is, at present, a wide variety of methods for the remote selection of linear (H/V) or circular (cw/ccw) polarization. Any constructor is therefore left free to make his own control circuit to go with the specific system configuration (steerable polarizer, coax-relay, remote-controlled ortho-mode feed, etc.).

Construction

As compared with last month's constructional intricacies, life is more or less back to normal with the present board. In fact, with component over-

lay and track layout Fig. 13 to hand no problems are envisaged.

The voltage regulators may be mounted either on the enclosure rear panel or on the bottom lid, whichever you think more convenient. Especially in the case of the 7812, adequate cooling is called for, and this should be duly observed if you insist on leaving the regulator on the board, where it can be expected to get very hot if it is only fitted with a TO220-style heatsink. The wire leading to the regulator input may conveniently be replaced by an empirically determined 5 W resistor, R_x (10-20 Ω).

R_{S1} and R_{S2} are mounted slightly off the board, and D_{S2} must be fitted with a smallish heat-sink. Beware of shortcircuits as the cooling fins are at ground potential.

All terminal holes on the PCB edges should be fitted with soldering pins (quite a few are required...).

Ready-made inductors L_{16} and L_{17} should not cause problems, as their positions are governed by the relevant PCB holes. Sockets may be used in all IC positions.

Refer to Table 2 for data on home-wound inductors L_{14} and L_{15} . The former is readily made, the latter requires a bit of constructional detailing, as it is critical in regard of the correct phase relationship between the three windings, whose starting points have been indicated as dots in the circuit diagram.

Refer to Fig. 14 to see how the Type 10K1 former has its base modified to create an additional "pin". If you are less familiar with winding inductors of this size, practise scraping off all enamel coating over a length of some 5 mm at the wire end without breaking it. Next, pre-tin it, scrape

lightly again and check for a smooth surface. The wire end thus prepared should be revolved around the relevant base pin (use pliers) and joined to it direct where this is seated in the ABS material, soldering rapidly to prevent damaging the base. And now for L_{15} .

1. Cut off a strip of 30 x 5 mm Sello-tape and put this somewhere within easy reach.
2. Wind f' - e, starting with f' at the base of the former, winding 25 closewound turns upwards. Determine the length of wire to connect to pin e; prepare the end as stated but do not actually make the connection yet. Instead, leave the wire end flying as you press the f' - e winding into place to make a *closewound* coil. Next, fix the winding with the strip of Sello-tape, still leaving the e end unconnected.
3. Starting from b' connect and close-wind the wire l_2 turns upwards, onto f' - e; the exact location is irrelevant. Connect to a.
4. Starting from d' (the wire end functions as a pin) wind four turns straight into the centre of b' - a. Connect to c.
5. Connect the flying top wire end to e.
6. Check for any short-circuits between windings and verify correct continuity at the pins.
7. The windings may be secured with a few drops of wax or Araldite.
8. Put the inductor assembly together and double-check its PCB position before fitting. Do not yet mount the screening can.

Check the completed board in the usual manner before wiring the receiver as shown in Fig. 15. Do not fit

the units in the enclosure yet, connect all controls in a provisional manner only, and hook up an ammeter to take the function of M_1 while testing the S-meter driver.

Alignment

Apart from the standard tools and measuring equipment available in most workshops, you need the following items for setting up the in-door tuner;

- A CVBS-input colour monitor or a suitable VHF/UHF vision modulator;
- an AF amplifier;
- a simple to control, preferably manually tuned, monochrome or colour TV set. Make a simple UHF pick-up device by plugging in a short length of coaxial cable, the open end of which is fitted with a 10 cm long probe wire;
- a nylon trim tool set;
- an LNB connected to K_1 by a short length of low-loss coax cable. It is, of course, even better to have it fitted and fully operative onto the dish, which should preferably be pointed at ECS-1 (vertical polarization). Once this is all done, the downlead cable should be connected to K_1 .

Handy, but not strictly necessary to achieve good results, are a grid dip oscillator (GDO), an oscilloscope, and a 1.2 GHz frequency meter.

After switching on, check all measurement values given in Figs. 2 and 11. If necessary, correct R_x and R_e to achieve correct biasing of T_2 and T_3 , respectively. Commence the alignment procedure by concentrating on the second board.

Pre- and de-emphasis is a technique used to improve the signal-to-noise ratio in a radio communication system that employs frequency modulation (FM) or phase modulation (PM). At the transmitter side the modulating signal is passed through a network that causes the higher frequencies to be less attenuated than the lower ones. At the receiver the reverse process (de-emphasis) is used to restore the original relative strengths of the modulating frequencies.

In the case of satellite TV reception, the transmitter is in fact the uplink centre, and the receiver is the indoor unit (note that satellite TV transponders merely convert and re-transmit the received uplink power; no modulation correction of any kind takes place, therefore).

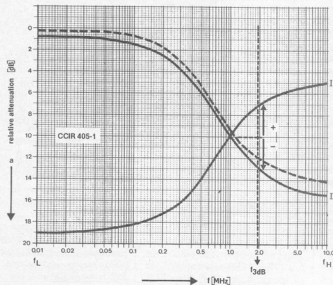

$$A = \sqrt{2} \Delta f_{90\text{dB}} / (20\pi f) = 5.91$$

$$T = 1/\Delta f_{90\text{dB}} = 0.506 \mu\text{s}$$

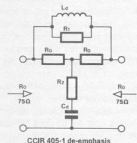

$$R_1 = (A - 1)R_0 = 300 \Omega$$

$$R_2 = R_0/R_1 = 18.7 \Omega$$

$$L_d = R_1 T / A = 35.5 \mu\text{H}$$

$$C_d = L_d / R_2^2 = 5.42 \text{ nF}$$

$$M_{90\text{dB}} = (A/20) \log_{10} [(1 + 1/A)^2 / (1 + 1/A^2)]$$

$$R_0 = Z_0 = Z_i = 75 \Omega$$

66082-2-12

Fig. 12. Pre-emphasis (I) and de-emphasis (II) characteristics to CCIR recommendation 405-1, which is applicable to most, if not all, 12 GHz transponders currently orbiting the earth. The dashed curve represents the response of a prototype version of the de-emphasis filter incorporated in the present design.

Fig. 13. Track pattern and component overlay of the single-sided second board in the IDU.

Parts list

Resistors:

R₂₂; R₂₃; R₂₄; R₂₅; R₂₆;
 R₂₇ = 75 Ω 1%
 R₂₈ = 300 Ω 1%
 R₂₉ = 20 Ω 1%
 R₃₀ = 6k8
 R₃₁; R₃₂ = 470 Ω
 R₃₃ = 8k2
 R₃₄ = 1k5
 R₃₅ = 180 Ω
 R₃₆; R₄₂; R₄₆ = 1 k
 R₃₇ = 10 k
 R₃₈; R₅₂ = 680 Ω
 R₃₉; R₅₄ = 330 Ω
 R₄₀ = 4k7
 R₄₁ = 100 Ω
 R₄₃; R₄₈ = 2k2
 R₄₄ = 220 Ω
 R₄₅ = 18 k
 R₄₆; R₄₇; R₅₀ = 22 k
 R₅₁ = 1 k ½ W *
 R₅₃ = 10 Ω ½ W
 P₁; P₃ = 10 k preset
 P₂; P₆ = 10 k linear potentiometer

P₄ = 5 k preset
 P₅ = 2k5 preset
 P₇ = 100 k linear stereo potentiometer

Capacitors:

C₄₆; C₄₇; C₆₁ = 22 p
 C₆₀ = 22 *
 C₄₈ = 4n7 polystyrene 5%
 C₄₉ = 680 p polystyrene 5%
 C₅₆; C₅₄; C₅₅; C₆₈ = 100 μF 16 V
 C₅₁; C₅₉ = 100 n Silbitit
 C₅₂ = 10 μF 16 V
 C₅₃ = 100 n MKT
 C₅₈; C₆₂; C₆₆ = 10 n ceramic
 C₅₇; C₅₈; C₅₉; C₇₅ = 1 n ceramic
 C₆₃; C₆₄; C₆₇ = 22 n ceramic
 C₆₈ = 47 μF 16 V
 C₆₉ = 4μ7; 16 V
 C₇₂ = 2200 μF 40 V
 C₇₃; C₇₄ = 220 μF 63 V
 C₇₅ = 10 μF 63 V
 C₇₆; C₇₇ = 10 μF 25 V

* See text.

All electrolytic capacitors are axial types. Specified working voltage is minimum.

Semiconductors:

T₄ = BF199
 T₇; T₈ = BC547B
 T₉; T₁₀; T₁₁ = BC557B
 D₅ = 6V2 zener 0.4 W
 D₄; D₁₃ = 1N4148
 D₇ = 8B405G

1. Set P₄ and P₅ to the centre of their travel, and connect the CVBS monitor to K₂.

2. Check whether the voltage across D₇ can be varied from 0.12 V, and subsequently peak L₁₆ and L₁₇ for maximum AF noise output. The core in L₁₅ should be adjusted until its top protrudes from the former.

3. Set P₇ to produce 10 V at V_{tone}; select LO_L.

4. Tune the TV set to UHF channel 36 or 37 (600 MHz, roughly) and carefully locate the probe wire close to the VCO inductor, L₈. Adjust C₂₇ until the screen is observed to go black for an instant, indicating the reception of the VCO carrier. As soon as this happens, C₂₇ should be left alone and the TV set is tuned over a few adjacent channels to locate the carrier. The initial adjustment for C₂₇ should be reached with the trimmer's rotor plates at about one third of their travel. If you use a frequency meter, simply adjust C₂₇ for a reading of 610 MHz (use inductive coupling). Set the wiper of P₇ to point at IC₃ (¼ of its travel).

5. The four bandfilter trimmers should now be peaked for maximum noise on the CVBS monitor. The indoor tuner only produces output video noise with an LNB connected to K₁.

The point where maximum noise is observed should be reached with all bandfilter trimmers set to about 40% of their travel; this is a good way of checking the correct functioning of

the four line inductors. Any trimmer with a widely deviating setting is indicative of wrong adjustment and/or a circuit malfunction. Output noise should be stable and free of tearing and horizontal lines. If necessary, correct the setting of P₁ to preclude overdriving the monitor (a scope should measure about 3 V_{pp} at the CVBS-1 output). Spend some time in adjusting the trimmers, as their settings interact slightly due to the critical coupling between the associated line inductors.

From the next step onwards it is assumed that a stable, relatively strong (C/N ≥ 10 dB) downlead signal is fed to K₁. A suggested dish positioning method will be given in part 3 of this series.

6. Turn P₇ to check whether LO_L has any undesirable dips in its output band. The dips are visible as a decrease in output noise, owing to the BFW 92 switching to another mode of oscillation; the effect can be

ruled out quite effectively by carefully pressing C_x towards the PCB. Over the entire tuning range, however, the occurrence of two or three of such dips is quite normal; but these should, of course, not coincide with satellite signals, as in that case reception of a specific transponder may be considerably impaired owing to lack of oscillator power.

7. Set V_{tone} to about 3.5 V and carefully press down C_x (LO_L) until a TV signal is observed to swish past; this is most likely Teleclub Switzerland (ECS-1, TWV). Do not alter the position of C_x anymore; instead, tune P₇-P₆ until the picture is at least stable.

Now realign the bandfilters, observing that the optimum trimmer settings do not differ dramatically from those obtained by peaking for maximum noise. Again, take the inductor interaction into account as you peak for optimum definition of the test chart

Table 2

Home-wound inductors

inductor	winding	SWG wire	turns	remarks
L ₁₄	a-b	24 enam.	14	closewound on T50-2 core (red & green; O.D. = 12.7 mm)
	c-d	24 enam.	5	
L ₁₅	f-e	36 enam.	25	all closewound on Neosid dia. 4 mm former Type 10K1; see Fig. 14.
	b-a	36 enam.	12	
	d-c	36 enam.	4	

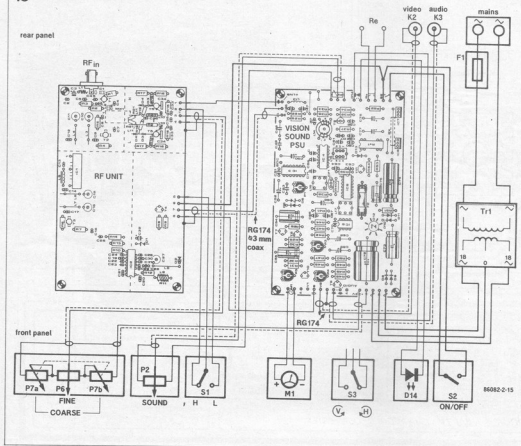

D₁, D₂, D₃, D₁₁ = 1N4002
 D₁₂ = TAA550 *
 D₁₄ = panel-mount LED
 IC₁ = NE582 (SGS-Ates)
 IC₂ = SO42P (Siemens)
 IC₃ = TBA1205
 IC₄ = CA3240E
 IC₅ = 7812 or 7812CV▼
 IC₆ = 7815 or 7815CV▼

* See text.
 ▼ Preferred type in view of higher permissible output current (1.5 A).

Inductors:
 L₁₂ = 33 μ H axial choke
 L₁₃ = 22 μ H axial choke
 L₁₄ = T50-2 core *
 L₁₅ = 10K-1 assembly * (Neosid)
 L₁₆ = KACSK3893A (Toko)
 L₁₇ = KACSK586HM (Toko)

* See text for winding details.

Miscellaneous:
 CF₁ = CFSH10.7M1 (Toko)
 F₁ = 200 mA slow
 F₂ = 250 mA slow
 K₂ = flange-type BNC socket
 K₃ = 5-way DIN socket
 M₁ = 200 μ A fsd rectangular S-meter, e.g. Cirkit 900 series.*
 Re₁ = 24 V DIL type, e.g. Hamlin HE721A5025

S₂ = miniature SPST
 S₃ = miniature SPDT
 TR₁ = 2 \times 18 V; 1 A
 Panel-mount fuseholder PCB-mount fuseholder Heat-sinks for D₁₂, IC₁ and IC₄.
 PCB Type 86082-2 Front panel foil Type 86082-F
 Enclosure Retex Type Ecobox 7610 Umhof-Bedco Standard Products Ltd, Uxbridge.
 Telephone: (0895) 371231 Size of the box is 300 \times 200 \times 70 mm.
 *See text.

on the screen. Realign P₁ if necessary. Tune across the LO_L band to observe the other transponders, which should be receivable with equal signal strength, except RTL-plus, which is beamed down on the satellite's east spot. LO_L should tune right up to SAT-1.

8. To get the most out of the indoor tuner, it may be worthwhile to carry out some experiments with slightly different settings of C₂₇, as the VCO output power is far from being stable over the 550-650 MHz range. Therefore, try a few adjustments of C₂₇, correct the tuning to capture the signal again, and realign the bandfilter trimmers for best reception (note that the requisite corrections should be very small). With a 10 dB C/N input signal fed to the tuner, reception should be clear and virtually free of sparklies.

9. Tune to SAT-1 (LO_H, ECS-1 10WV), and set P₂ to the centre of its travel. Carefully adjust the core in L₁₅ until the main audio channel is heard. Peak L₁₇ for undistorted audio at maximum amplitude. SAT-1 transmits two more audio programmes: the VOA (Voice of America) and ever-present background music; both, however, at reduced power and bandwidth with respect to the main

subcarrier. This fact makes the background music channel eminently suited for the fine adjustment of L₁₅. If correctly aligned, the tuner will output this channel with virtually no noise, given the previously stated C/N value.

Europa TV (ECS-1, 3WH), like no other transponder, demonstrates the quality of the proposed sound processing method; all five subcarriers carrying simultaneous translations of the daily broadcast news bulletin can be received by simply tuning P₂. 10. In case you are unable to receive any audio programme, check the oscillator frequency of IC₄ by means of a GDO or a frequency meter connected capacitively to pin 10 or 12. A scope is also usable, provided its bandwidth is adequate. C₆₆ determines the centre frequency of 18 MHz, while C₆₇ determines the tuning range, which should be a minimum 4 MHz to cover the full sub-carrier band.

11. Finally, adjust P₄ and P₅ for an ammeter indication corresponding to the fsd current of M₁ when reception is optimum. The meter should also indicate the relative strength of spot-east transponders RTL+ (8EV) and 3-SAT (2EH), i.e. P₄ and P₅ should be set to produce any, rather than no

meter deflection at all, while the higher PFD channels still produce full scale deflection on M₁. The adjustment of P₄ is quite critical in this respect, and care should be taken to avoid overloading the meter coil.

12. Assuming that ECS-1 is still being received with vertical polarization, C₆ in LO_H should be bent down as far as possible without losing Music Box from the tuning dial. It is perfectly possible that either LO_L or LO_H covers the full LO injection band. However, in that case there are likely to be rather more dips, jeopardizing reception of some of the transponders.

The enclosure

Not much needs to be said about the fitting of the tuner into the stated enclosure, but a few details require attention.

K₁ should protrude from a 15 mm hole in the rear panel; the socket flange should rest against the panel inside, while the bottom lid of the RF unit is secured onto the utmost left of the enclosure bottom lid. In this way, the RF unit is readily removable. Note, however, that the foregoing set-up may require all eight mounting

Fig. 15. Wiring diagram of the indoor tuner. For reasons of clarity, the two boards are shown further apart than they are in actual practice.

Fig. 14. Inductor L_{15} is the main part of the tuned tank circuit, of a symmetrically-ended oscillator contained in IC₄. All windings should be made bottom to top of the former, and in counterclockwise direction as shown.

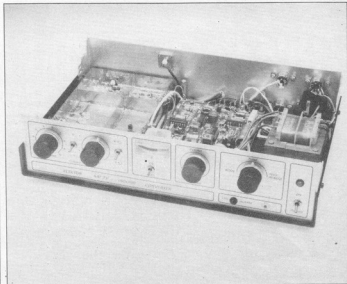
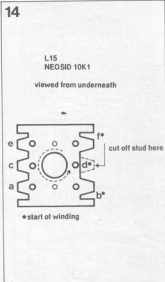

16

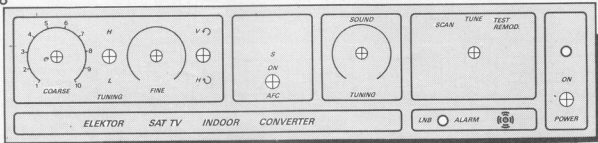

Fig. 16. The front panel of the tuner makes for a neat appearance in the living room. The foil for it is available through our READERS SERVICES (see p. 78). Since suitable rectangular S-meters come in a variety of sizes, the relevant aperture should be made only when the dimensions of the meter are known.

Fig 17 Further in the photographs published on P. 29 in our October issue here are some more showing test cards received from ECS-1

brackets in the Ecobox to be removed. The second board must be mounted on 5 mm spacers, right next to the RF unit, leaving ample space at the right for the power transformer and fuseholder for F₁.

Drilling the front panel should not cause problems, as the front panel foil for this project may serve as the template (see Fig. 16).

Note that the MODE selector is part of the optional circuitry to be detailed in Part 3; for now, a 2-pole, 3-way rotary switch plus knob may already be mounted.

Next time

The third and final article in this series will be published in the February 1987 issue of *Elektor India*. Details will be presented of a final, optional board, to be mounted on top of the one you have just completed. It holds an AFC circuit, a VHF vision & sound remodulator plus video test source, and a scanner circuit to sweep across the receiver frequency range to facilitate dish positioning.

Also, the measurement data, promised last month but too bulky for in-

clusion in the present instalment, will be discussed in some detail.

RGK,Bu

Corrigenda to part 1

(Elektor India, November 1986)

1. Please correct the following textual errors:

p. 56: "...that a 1.2 m and 1.8 m dish aerial..." should read "...that a 1.2 m to 1.8 m dish aerial..."

p. 57: "...to give an output of 10.95-11.75 GHz." should read "...to give an output of 950-1750 MHz."

Component availability
All semiconductors for the board described in this article are available from Universal Semiconductor Devices;
17 Granville Court, Granville Road, Hornsey, London. Telephone 01-348 9420/9425; telex 25157 usco g.

A kit comprising all parts for the RF section detailed in part 1 will shortly be available from Piper Communications;
4 Severn Road; Chilton-Didcot; Ox-on OX11 0PW. Telephone: (0235) 834328.

Neosid inductor assemblies are available from Neosid; Eduard House; Brownfields; Welwyn Garden City; Hertfordshire AL7 1AN. Telephone: (0707) 325011; telex: 25423.



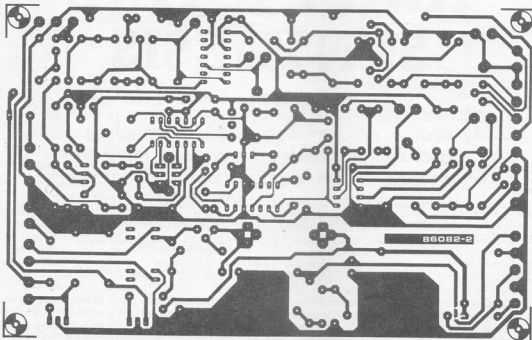

Hot ICs - no need for fear

It is perfectly normal for ICs particularly bipolar digital ICs such as TTL, to become very warm in operation. These ICs draw considerable power which is finally dissipated as heat. An example is the common TTL IC 74145. Typical dissipation for this device is 215 mW and approximately 360mW maximum; this is in the quiescent state with unloaded outputs. When these are loaded the dissipation is even higher. Since the area of the IC package is relatively small, the IC becomes very warm indeed. This is no problem, however; it is rated appropriately and operates perfectly even at ambient temperatures of upto 70°C. When the computer is

installed in a housing, care should be taken to provide ventilation slots for the heat to dissipate. In the event of doubt regarding the temperature rise of ICs, the data sheet should be consulted; an IC with a maximum dissipation of 10 mW for instance, should not exhibit noticeable temperature rise.

The Microcomputer as a source of interference

Every microcomputer system operates with relatively fast logic ICs, such as Schottky

TTLs. This means that the digital signals have rapid-rise slopes which produce harmonics extending far into the VHF/UHF region. This cause interference, and not only to FM stereo reception. The problem is not restricted to home made microcomputers; some commercially built microcomputers, particularly teaching and experimental system, can unfortunately be classed as sources of electromagnetic pollution. The only solution is to install the microcomputer in a (metal) screened housing with an earth connection; it may also be necessary to fit a mains RF-suppression filter. Screen need (coaxial) cable should be used for connections between the computer and peripheral equipment. These precautions apply to all digital equipment using fast logic.

SOUND SAMPLING AND DIGITAL SYNTHESIS

by D Doepfer & C Assall

Nowadays, phrases such as sound sampling and digital synthesis crop up more and more often when "insiders" are talking about electronic music or electrophonic instruments. Although on the face of it these two concepts have little in common, this is a false impression as the following article shows.

A sound sampler is intended to be fed with a random range of sounds, process this if required, and output it as a series of discrete tones. Changing the frequency of the tones is normally effected by means of a keyboard, so that a sound sampler can be played like any other keyboard instrument.

Operation

The AF output signal of a microphone, tape recorder, or record player is stored and then reproduced. To this end, the signal is transformed into a series of (binary) digits in an analogue-to-digital converter (ADC), after which the digits are stored in a digital random-access memory (RAM) or read-only memory (ROM). The converter is not able to scan the entire audio frequency range of 20 Hz to 20 kHz continuously. Instead, it samples the signal at regular, defined intervals of time, and only these samples are converted and stored. Research has shown that a band of signals must be sampled at a frequency of

not less than twice the highest frequency occurring in the band to prevent loss of information. For the present purposes, the upper audio frequency will be taken as 16 kHz, which means that the sampling rate must not be less than 32 kHz. Lower sampling frequencies would result in aliasing: the alias signal has a frequency that corresponds to an harmonic of the sampled signal. Since the bandwidth of the incoming AF signal varies according to the signal source, the input of a sound sampler is invariably provided with an anti-aliasing (low-pass) filter as shown in Fig. 1. The cut-off frequency of this filter must not be greater than half the sampling rate. It may be variable as, for instance, in an integrated voltage-controlled filter (VCF), so that a variable sample rate can be used. Sampling rates greater than 32 kHz result in improved sound quality (because of the greater scanned bandwidth), but, since more digits then have to be stored during the same time interval, mean that

the memory must have a correspondingly larger capacity.

Because the level of the input signal to the ADC must not change during the conversion process (since useless binary digits would result), a sample-and-hold (S&H) circuit is introduced between the ADC and the filter. This circuit derives a sample from the AF signal at fixed time intervals: (every 31.25 μ s at a sample rate of 32 kHz) and holds the level of this sample steady at its output until the next sample is taken. Basically, a sample-and-hold circuit consists of a switch, a capacitor, and a buffer-amplifier. When the switch is closed, the output of the circuit follows the input; when it is open, the last voltage level at the output is retained. The switch is an electronic type such as a field-effect transistor (FET) or CMOS switch. Sample-and-hold circuits are also available as integrated units.

The conversion of the analogue signal into a digital code must be completed within a slightly shorter time than 31.25 μ s (at a sample rate of

32 kHz), because the S&H circuit also needs a finite time to come into operation. At the same time, no distortions must be introduced that would impair the final sound quality.

The resolution (in bits= binary digits) of the ADC stands in direct relation to the signal-to-noise (S/N) ratio and the dynamic range. The dynamic range is the range over which the ADC can produce a suitable output signal in response to an input signal. It is often quoted as the difference in decibels between the noise level of the device and the level at which the ADC is saturated (i.e. the overload level).

In practice, good resolution is taken as 1 bit for a dynamic range of 6 dB; that is, an 8-bit resolution gives a range of 48 dB; 10-bit=60 dB; 12-bit=72 dB; and 16-bit=96 dB. The choice of resolution is largely a matter of cost: on purely technical considerations, 16-bit resolution is, of course, preferable to 10-bit, but unfortunately good-quality 16-bit ADCs cost around

Fig. 1. Block diagram of a typical sound sampler.

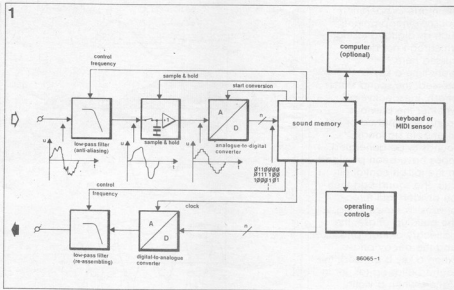

£300. Furthermore, 16-bit resolution would put heavy demands on the S&H circuit as well as on the filter, and this would further increase costs. Finally, 16-bit resolution requires double the storage capacity of that for 8-bit resolution.

Fortunately, 8-bit resolution is perfectly satisfactory for most applications, but it requires optimum use of the dynamic range. Problems are only likely to arise with signals that cover a large range, for instance, those that have a large peak value at the onset and a very small one at the end. The *quantization distortion* will be quite audible at the end of such signals. This problem can be cured by higher resolution, e.g. 12-bit, or by an inexpensive *comparer*. A comparer is a combination of *compressor* and *expander*. A compressor automatically reduces the range of amplitude variations of an AF signal at the input of a system, whereas an expander automatically extends the range of amplitude variations at the output of the system. An 8-bit system with a suitable comparer yields results that are comparable to those of a 12-bit system.

The bit stream at the output of the ADC is stored serially in a digital sound

memory. The capacity of this memory for a sound of 1 s duration, 8-bit resolution, and 32 kHz sampling rate must be 32 Kbyte [1 Kbyte=1024 (2^{10}) bytes]. The run-off control for writing the data into the memory can be effected by means of the software of a microprocessor system. This software (in machine language) must be fast enough to read the output of the ADC, write the value into the memory, and increase the memory address (high/low byte) by 1 every 34.25 μ s. Even simple 8-bit processors with an 8-bit index register are suitable for this.

Writing may be started manually (pressing a key or pushbutton), or automatically as soon as the AF signal exceeds a given threshold level. Manual starting is normally used when from a range of sounds only a particular band needs to be sampled. Automatic starting is preferred for the sampling of the sound from individual instruments.

When the memory is full, writing is stopped, and the sound is available as a series of 32×2^{10} bytes. This series can be further processed with the aid of customer-made software and/or transferred to a main store such as a floppy disk.

To reproduce the stored digital code as an analogue sound, the bits are converted in a digital-to-analogue converter (DAC) at the output. The timing rate resulting from the reversion process determines the cut-off frequency of the (low-pass) re-assembling filter that feeds the DAC. Since the timing frequency varies with the frequency of the reproduced signal, it is important that the cut-off frequency is in tandem with the clock. The re-assembling filter should, therefore, preferably be an integrated, voltage-controlled type, for instance, the CEM3320.

If the data are read from the memory at the same speed as they were written, the output signal is a replica of that at the input. If, however, the reading speed is varied, the frequency of the output signal is altered. If the reading speed is controlled from a keyboard, it is thus possible to play back the original signal at a different pitch. The run-off control for reading the data from the memory may be provided by a computer or specially designed hardware. This hardware is basically a binary counter the clock of which is fed by a signal whose frequency is determined by whichever key on the

keyboard is pressed. Traditional systems operating with the 1 V/octave standard contain a fast voltage-controlled oscillator (VCO) that converts the voltage from the keyboard into the requisite frequency. The control voltage is also supplied to the frequency-control input of the re-assembling filter, so that the filter operates in tandem with the play-back sampling rate. A gating pulse, also provided by the keyboard, starts the actual play-back.

In digital systems operating in accordance with the MIDI standard, the MIDI data are obtained from a suitable peripheral device, such as the 6850. The MIDI data are converted by a computer into a suitable signal to drive a high-speed oscillator whose output is used to read the memory. If the computer is fitted with a fast processor, such as the 68000, a programmable counter, for instance an 8254, may be used instead of the high-speed oscillator, in conjunction with suitable customer-designed software. The memory is then not read with a variable frequency, but at a fixed sample rate with variable increment. In this manner, the output signal will deviate from the input according to the increments. Unfortunately,

this mode of operation causes other problems, such as digital aliasing, which can not be discussed here.

Every time a key is pressed, the sound starts afresh, irrespective of whether the previous sound has finished or not. To enable stationary sounds to be generated, loops have been provided in the roll-off control circuit. The sound can then be divided into three phases as shown in Fig. 2: the build-up phase; the stationary or loop phase; and the decay phase.

When a key is pressed, the sound builds up (as, for instance, when a violin string is bowed); then remains stationary (like the sound from the violin after it has been bowed) as long as the key is pressed; and finally decays when the key is released.

The instants at which the standing phase begins and ends are under the control of the musician, although a computer can be a very useful tool here, as when, for instance, it is predetermined that only zero crossing of the signal will be used as starting and finishing points. The loop must be a whole multiple of the period of the signal to avoid annoying clicks at the change-over points.

Determining the loop is normally quite straightforward with monophonic (from Greek for "single sound") instruments. Generally, the loop will embrace at least a couple of periods, as this will make the sound rather livelier. Occasionally, beats, frequency fluctuations, and other spurious effects may cause a diminution of the liveliness; a chorus, phasing, flanging, or delay unit connected at the output may improve matters again.

If the input signal has already been processed with a periodic effect, such as vibrato (=slow frequency modulation); tremolo (=slow amplitude modulation); phasing; or flanging, the effects fre-

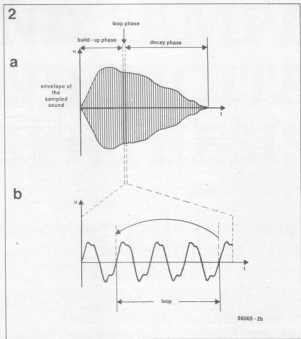

quency must be taken into account in the loop, otherwise the effect would be lost in the standing phase, although it is present in the two other phases. With polyphonic (from Greek "simultaneous sounding of different notes") inputs, such as from a choir or orchestra, determining a properly working loop is at best difficult and often impossible. The difficulty revolves around finding two change-over points that are suitable for all instruments contributing to the polyphonic sound. It is often possible to arrive at a compromise by taking a very wide loop (up to 400 periods) and negating the ensuing slight distortion by using a chorus unit or delay line at the output. The crucial information of most instruments is contained in the build-up phase, so that the storage allocation for the standing phase can be kept relatively small. The signal output by the DAC may undergo further analogue processes. It is, for instance, possible to modify the high-frequency content with the aid of a voltage-controlled filter (VCF) and a wave-form (envelope) generator, or the loudness level with a

voltage-controlled amplifier (VCA) and a wave-form generator.

Independent of such further analogue processes, the signal may also be digitally modified by a computer while still stored in the memory. In conjunction with a graphics display on the monitor, the sound can be partially erased, shifted, duplicated, or inverted (backwards). Inversion of percussive sounds particularly leads to interesting structures.

The signal may be given a completely new amplitude envelope and be displayed graphically in different forms. If the computer is sufficiently powerful, the sound may also be subject to Fourier analysis, and after appropriate modification be synthesized anew.

As already stated, the computer is also a powerful tool in the determination of the loop start and finish. If, for instance, it has a mass storage device, such as a floppy disk, sounds and associated loop values can be stored indefinitely, which makes it possible to build up a complete sound library. Musicians can interchange all kinds of sound, while manufac-

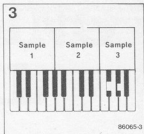

Fig. 2. Division of the sampled sound into three phases: the (central) standing, or stationary, phase is shown with extended time axis in 2b.

Fig. 3. Typical keyboard for use in multi-sampling.

urers can produce and market standard sounds on chips. Making the output signal faster or slower than the input signal gives rise to the so-called Mickey Mouse effect, because the sound becomes more and more unnatural the farther the output speed is from the input speed. The effect is caused by a shift in the resonance frequency or formant structure when the output pitch is changed by varying the reading speed. Each instrument has its own distinct variation of the effect: the less pronounced its formants are, the less noticeable the effect is. The effect is kept in check by multi-sampling, in which in different tone ranges (e.g. each octave) several sounds are sampled (see Fig. 3). During playback, only the input sound nearest in frequency to the required output tone is used. In extreme cases, each semitone is stored at its own address. Since this requires an enormous memory capacity, such extremes are not (yet) encountered in practice. A not insignificant problem with multi-sampling is the proper matching of the various frequency ranges (as, for instance,

equal loudness level) so that the transition from one range to another is not noticeable.

There is another, not so well-known, method of multi-sampling, which does not depend on the selection of different frequencies, but on the dynamics of the instrument. A lightly struck piano key causes a different sound than when it is struck hard; the same is true for virtually all instruments. It is, therefore, possible to use different memories for different degrees of touch. During playback, it depends on the dynamics of the key, or on the MIDI information as to the dynamics, which memory will be read. Unfortunately, this method of multi-sampling requires very expensive equipment and is, therefore, hardly found in commercially available equipment.

Sound samplers are available as monophonic or polyphonic instruments. Monophonic models can generate only one sound at a time, whereas polyphonic types produce several sounds simultaneously. The latter are sub-divided into models with one common memory for all sounds, and models that have a memory for each different register. In the latter, each register can produce its own distinct sound, which, in conjunction with multi-register sequences, has, of course, the great advantage that each register can be used with a different instrument (MIDI mono mode possible).

Polyphonic equipment with only one sound memory generates the same sound for each register, but can, simultaneously, do so at different pitch.

Digital synthesis

It has been seen that during the recording of a sound a series of data, representing that sound, is stored in a memory. Any computing technique by

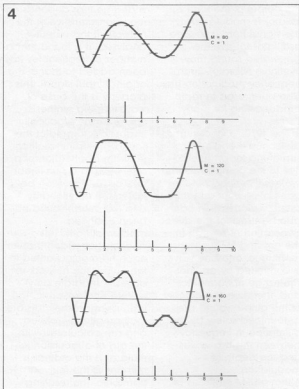

Fig. 4. Sounds generated by the Fourier synthesis technique: M is the percentage modulation and $C=1$ indicates that the fundamental and modulating frequencies are equal.

which a series of significant data could be created in the memory without sampling would afford pure synthetic sounds. In principle, there are many methods by which random series of data can be produced, but for the purposes here the series must be musically acceptable, clearly arranged, and, moreover, there should be a simple relation between the recording characteristics and the sound output. These requirements reduce the available techniques to:

- Fourier synthesis (also called harmonic synthesis);
- frequency-modulation (FM) synthesis;
- waveshaping synthesis;
- phase distortion synthesis.

Since the tones are available in digital code, it is possible to manipulate them in all possible variations. It is, for example, possible to play back a digital sound backwards, or to mix, combine, or modulate it with a second tone. Other effects, including doubling; echo; reverberation;

flanging; chorus; harmonizing; ring modulation; imposing on a new envelope; and fast Fourier transform with subsequent re-synthesis are possible with the aid of suitable software. It is noteworthy that all these effects can be realized with hardly any extension of the hardware.

Manipulation of natural sounds, extending beyond mere sampling and storing, belongs to a new technique of sound generation: *digital sound synthesis*. In its pure form, it obviates the need for an analogue input unit. In this technique, a waveform is produced direct by a computer system that is controlled by a mathematical algorithm. The tone is determined by the method which, in the truest sense of the word, synthesizes a waveform. The main difficulty here is to describe the waveform as precisely as possible with only a limited number of parameters. An extreme example would be to read the tone point by point, but, apart from making the reading procedure a very longwinded

affair, there is also the difficulty of determining the spectral constitution of any given sound. Modern synthesis techniques seek a compromise between the number of defining parameters and the specified output. Since each method can only take account of certain aspects, its mathematical structure results in definite characteristics which are clearly identifiable in the final sound.

Fourier synthesis

Since synthesis is the opposite of analysis, and Fourier analysis enables any waveform, no matter how complex, to be represented by a series of simple sine waves that are harmonically related, it is possible to build a complex waveform from a number of sine waves. This mathematical concept does not need a digital synthesizer to put it into practical form, for it has been used for a very long time in the generation of sounds in organs. However, because of technical

limitations, only a relatively small number of controlled harmonics can be realized in these instruments.

The modern computer has made it possible, at least in theory, to make a virtually unlimited number of harmonics available, whose amplitude can be controlled very precisely. In practice, however, only thirty-two harmonics are generally used, because the computing time rises with each harmonic. The great benefit of digital Fourier synthesis is that it makes it possible to give each sound its own harmonic spectrum.

To prevent too great an input (writing) complexity, only two reading methods are used in practice. With the first, a separate amplitude envelope is input for each harmonic; the envelope extends over the entire length of the sound to be computed. With the second method, the overall spectrum is written for each separate period; the intermediate values of the as yet undefined periods are then interpolated by the software. The second method has some advantages as well as some disadvantages as compared with the first. Advantages are:

- the input is strictly analytical and there is, therefore, a direct relation between the input and the final output;
 - there is accurate control of tones in each individual period.
- Disadvantages are:
- greater input complexity;
 - relatively long computing times;
 - harmonics that fall outside the proposed frame can not be used;
 - the computed waveform does not by itself attain maximum amplitude so that additional and intricate regulation is required before and after the computation.

the output of the tone oscillator is modulated by the signal from a second oscillator to give the generated sound more liveliness (vibrato). Such frequency modulation has also been used in radio broadcasting for many years.

In the 1970s, J Chowning, an acoustic engineer searching for an alternative to the complex Fourier synthesis method of tone generation, found that frequency modulation can also be used for the direct generation of sounds. In the ensuing FM synthesis technique, one sine wave is controlled by another. The range of harmonics and, therefore, the colour of the output sound are determined solely by the difference in frequency between the two waves and the depth of modulation.

Although FM synthesis offers a real easing of the writing procedures, it does not provide a direct relation between the input and final output signal. Consequently, it requires much experience and trial and error to produce sounds of a predetermined character. It is not possible to deliberately influence the harmonics in the output signal.

Summarizing, FM synthesis has the following advantages:

- fairly easy writing procedure;
- short computing time;
- depending on the relation between the two sine waves, even non-harmonic frequencies may be generated;
- the waveshape is always computed with maximum amplitude; and the disadvantage that analytic tone generation is not possible.

Waveshaping synthesis

If a sinusoidal signal is applied to the input of a non-linear network, the output will not be a sine wave, but be distorted to

a degree that depends on the characteristics of the network. If this output is analysed, it is found that a number of frequencies has been added to that of the original input signal. This property is the basis of waveshaping synthesis. It is, however, practically impossible to predict the sound spectrum resulting from the application of a sine wave to a non-linear network. The relation between the non-linearity and the output sound has been analysed mathematically. This analysis has shown that for each harmonic wanted in the output the network requires a separate polynomial characteristic. The individual polynomials are mathematically related and are calculated with the aid of a recursion formula and the ordinal number of the relevant harmonic. The resulting row of polynomials is known as the Chebishev polynomial.

To obtain a number of suitably weighted harmonics in the output spectrum, each relevant non-linear characteristic is calculated with the appropriate weighting factor. The resulting polynomials are added together to arrive at the composite non-linear function from which the network constituents can be computed. A sinusoidal signal applied to the resulting network will give rise to an output sound that contains all the predetermined harmonics in correct proportion. The waveform of the output sound can be varied simply by altering the content of the non-linear function, i.e. by changing the value of one or more components contained in the network.

Summarizing, waveshaping synthesis combines certain aspects of Fourier synthesis, i.e. the analytical sound construction, and FM synthesis, particularly the simple writing procedures and the short computing time required. It has these advantages:

- simple writing procedure;
 - analytical input character;
 - short computing time;
 - the technique of waveshape distortion is modelled on the tone generation by "natural" instruments, so that in many situations it is possible to synthesize simple and natural sounding tones.
- Disadvantages of waveshaping synthesis are:
- harmonics can not be controlled as accurately as with Fourier synthesis;
 - it is difficult to achieve optimum control of the final waveshape;
 - it involves complex mathematical relations and operations.

Phase distortion synthesis

Phase distortion synthesis is, to some extent, a combination of FM synthesis and waveshaping synthesis in that a non-linear network is used to alter the phase angle of the sinusoidal input signal. From a mathematical point of view, this technique is a special case of FM synthesis. Here again, there is no clear relation between the non-linear function that causes the change in phase angle and the resulting sound. None the less, this technique enables a fairly easy simulation of the tone generation of analogue synthesizers operating with the subtractive synthesis method. In practical terms, the non-linear network causes the output sound to have a shape that can be varied between sinusoidal and sawtooth. The resulting sound could be said to vary between "analogue" and "digital".

FM synthesis

In analogue synthesizers,

sensitive lightmeter

Most commercially available lightmeters still use cadmium sulphide photoresistive cells, which suffer from such disadvantages as slow response time, especially at low light levels, and a spectral response that does not match that of the human eye. A lightmeter using a silicon photodiode has considerable advantages over meters using photoresistive cells: the spectral response can be made much closer to that of the human eye (and of photographic film), the response time is sufficiently fast, and finally, the response to light is linear.

Unfortunately, from the photographer's point of view, silicon photodiode metering is available only in the most expensive cameras with built-in metering, so a design for a home-built, hand-held silicon photodiode lightmeter would seem to be a good idea. The circuit given here will measure light levels from 10 lux to 10,000 lux in four ranges, which is adequate both for the measurement of illumination and for photographic purposes.

The complete circuit of the lightmeter is given in figure 1, and operates as follows: light falling on photodiode D1 causes it to generate a negative voltage with respect to the 0 V rail. This causes the output of IC1 to swing positive, driving current round the feedback loop into D1. This current causes a voltage drop across the diode's internal resistance, which is in opposition to the voltage generated by D1. The output of IC1 takes up a positive voltage such that the two voltages cancel, i.e. the voltage at the inverting input of IC1 assumes the same potential as the non-inverting input — zero volts.

The output voltage which IC1 assumes is proportional to the feedback loop current required to cancel the photodiode voltage. This is proportional to the photodiode voltage, which in turn is proportional to the light falling on the photodiode. In other words, the output voltage of IC1 is proportional to the amount of light falling on D1.

Since the current through the photodiode is fairly small, if the feedback resistors were connected direct to the output of IC1 they would have to be impossibly large to obtain a reasonable

The lightmeter described in this article utilises a silicon photodiode, the most up-to-date method of light measurement, and may be used either for photographic purposes or for the measurement of illumination.

output voltage from IC1. To overcome this difficulty the output of IC1 is attenuated by a factor of 10 by R4 and R5. This also gives the possibility of an extra range, as will be explained later.

Three basic ranges are provided, 10 lux, 100 lux and 1000 lux, selected by means of S1 and calibrated by P1, P2 and P3. Pressing S2 shorts out the attenuator on the output of IC1, thus allowing a times ten multiplication of the ranges, or a maximum reading of 10,000 lux. If this highest range is not required then S2 can be omitted; R5 can be 1 k in this case. If, on the other hand, the lowest range is not required, S2 and R5 can be omitted and R4 replaced by a wire link.

Construction

A printed circuit board and component layout for the sensitive lightmeter are given in figure 2. The compact layout allows the lightmeter to be housed in a very small case, with ample room for a small 9 V battery such as a PP3. The current consumption of the lightmeter is only a few mA, so the battery should last for many months of normal use. S3 may be a non-latching pushbutton to avoid the possibility of the meter being left switched on.

Calibration

This is always a problem with any home-built measuring instrument, especially a lightmeter, which should be calibrated against a standard light source. Fortunately, a sufficiently accurate calibration for most purposes can be achieved using ordinary domestic lamps. A normal 240 V, pearl, incandescent lamp has a light output between 10 and 15 lumens per watt. If it is assumed that the lamp radiates uniformly in all directions then the illumination at any distance from the lamp is easily found. The point at which the illumination is to be measured is taken as being on the surface of a sphere, at the centre of which is the lamp. The illumination in lux (lumens per square metre) is found simply by dividing the light output of

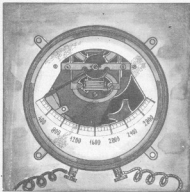

1

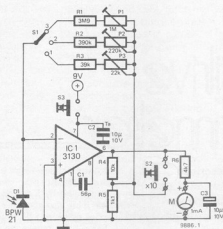

Figure 1. Complete circuit of the sensitive lightmeter.

Figure 2. Printed circuit board and component layout for the sensitive lightmeter (EPS 9886).

Figure 3. When used for photographic purposes the acceptance angle of the photodiode is too great and must be reduced by a lens or tube.

2

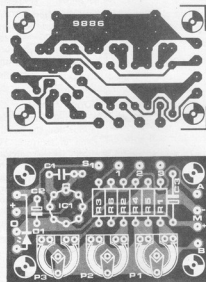

Table 1.

lamp	distance from lamp to photodiode	illumination
60 W	240 cm	10 lux
60 W	105 cm	50 lux
100 W	100 cm	100 lux
100 W	45 cm	500 lux
100 W	30 cm	1000 lux
(100 W	13 cm	approx. 5000 lux)

Parts list for figures 1 and 2.

Resistors:

R1 = 3M9
 R2 = 390 k
 R3 = 39 k
 R4 = 10 k
 R5 = 1k1 (see text)
 R6 = 4k7
 P1 = 1 M
 P2 = 220 k
 P3 = 22 k

Capacitors:

C1 = 56 p
 C2 = 10 μ /10 V tantalum
 C3 = 10 μ /10 V

Semiconductors:

D1 = BPW 21 (Siemens)
 IC1 = 3130

Miscellaneous:

S1 = single-pole 3-way switch
 S2 = push-to-make switch
 S3 = push-to-make switch
 M = 1 mA meter

the lamp by the surface area of the sphere, i.e.

$$I = \frac{\Phi}{4\pi r^2}$$

where I is illumination in lux
 Φ is light output in lumens
 r is distance from lamp in metres.

This equation is valid only if the lamp radiates uniformly, and for this reason only standard pearl lamps must be used for the calibration procedure. Spot-lamps, high output lamps or lamps with any other internal reflector or coating are not suitable. Table 1 gives a list of

useful distances with corresponding illumination levels.

Two lamps are required for the calibration procedure, a 60 W lamp and a 100 W lamp. The lamp must be mounted in a plain lampholder without reflector, and should be the only source of illumination. The calibration procedure must be carried out away from reflecting surfaces such as mirrors or light painted walls.

The calibration procedure is as follows:

1. Set the lightmeter to the 10 lux range and place it at a distance of 240 cm from the 60 W lamp. Adjust P1 for full-scale deflection of the meter. Now place a piece of thick card between the lamp and the light-

meter, when the reading should drop to less than 10% full-scale. If it does not then something in the room is reflecting light onto the photodiode.

2. Change to the 100 W lamp and set the lightmeter to the 100 lux range. Place the lightmeter to the 100 lux range, from the lamp and adjust P2 for full-scale deflection.
3. Set the lightmeter to the 1000 lux range and place it 30 cm from the lamp. Adjust P3 for full-scale deflection.
4. Check that the calibration still holds when the x10 button is pressed, e.g. the same reading is obtained on the 1000 lux range as on the 100 lux range with the x10 button pressed.

3a

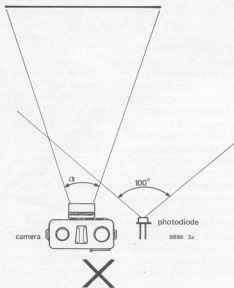

3b

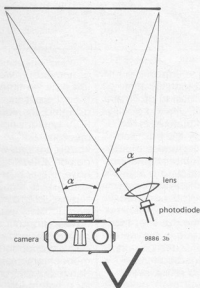

Table 2. Recommended illumination values in lux for various tasks.

class of visual task	example	recommended illumination (lux)
casual seeing	hallway	100
ordinary tasks, medium size detail	making cabinets for electronic projects; domestic living room	400
severe prolonged tasks, small detail	building a project on a p.c. board; studying	800
very severe tasks, very small detail	building a maximum-component-density prototype; detailed drafting	1500
exceptionally severe tasks, minute detail	watchmaking	3000

Photographic use

Calibration for photographic use presents further problems, since an absolute calibration procedure is almost impossible. The best method of calibration is to beg, borrow or steal an existing exposure meter to use as a reference.

Another problem exists with acceptance angle, since the BPW 21 photodiode will accept light over an angle of about 100°. This is much wider than the acceptance angle of the average camera lens, and means that the lightmeter will 'see' a different scene from that seen by the camera, including large areas of bright sky. This can easily result in false

readings. The acceptance angle of the lightmeter must therefore be reduced by putting a convex lens in front of the photodiode, or by putting it in a tube. This principle is illustrated in figure 3. To calibrate the lightmeter against a commercial exposure meter, the two are placed side by side and pointed at scenes of varying brightness. A table of lightmeter reading versus exposure meter reading is made, and this can later be used to calibrate the scale of the lightmeter. The lightmeter reading is then used in conjunction with the photographic film speed to find the correct exposure, which is basically the correct combination of shutter speed and aperture setting.

Unfortunately it is not possible to give a detailed calibration procedure for this method, since the scales of commercial exposure meters vary greatly, some giving a light reading that must be translated into an exposure value, and others giving a direct readout of shutter speed and aperture setting.

However, the calibration should not pose too much of a problem for the experienced photographer.

A second calibration procedure is possible, based on the calibration as luxmeter given above. The 'calibrated' lux scale can be converted to a photographic lightmeter scale on the basis of the following knowledge:

- for a 21 DIN (100 ASA) film, 120 lux on the scale is equivalent to a lens aperture of f16 at a 1 sec. exposure time;
- an increase by a factor 2 of the illumination reading in lux corresponds to a 1-stop increase in lens aperture, or a decrease by a factor 2 of the exposure time, or an increase of 3 points on the DIN scale, or doubling of the film sensitivity value on the ASA scale.

To give an example: if a 24 DIN (200 ASA) film is used (an increase by a factor 2 in sensitivity) and the lightmeter gives an indication of 240 lux (also an increase by a factor 2), correct exposure could be obtained at f16/1/8 sec, or f11/1/8 sec, etc.

Regrettably, this calibration will probably prove insufficiently accurate for photographic use: it may well be one or two stops out. For this reason, it will be necessary to make a few test exposures for final calibration. ■

THE BATTLE FOR SUPERTELEVISION

Europe and Japan are waging a technobattle over how best to provide the public with top-quality television pictures in the 1990s. Over the past decade, the Japanese broadcasting authority, NHK, has been perfecting a high-definition television system that uses 1,125 horizontal lines across the screen, instead of the 525 lines they and the Americans use at present. This offers much finer grained pictures—better, in a sense, even than film.

The Japanese, with the Americans and Canadians in tow, have been pushing hard to get their high-definition television (HDTV) system adopted as a world standard. The Europeans are adamant that it should not be. At a recent meeting of the International Radio Consultative Committee in Yugoslavia, they managed to get the issue deferred for another four years of discussion. With better-quality pictures from 625-line television, Europe's broadcasting engineers do not see the NHK proposal as an answer to their own problems.

The two sides have so little in common that four years may not be long enough to reach a consensus. For a start, America and Japan both have electricity supplies that alternate at 60 Hertz (cycles per second), while Europe and most other places have 50-Hertz electricity. Television scenes illuminated with light blinking 60 times a second (eg, in America) produce a shuddering effect when displayed on television sets which have their pictures refreshed 50 times a second. Europe's viewers tolerate shudder on the occasional American pro-

gramme. They would not like it all the time. Then there is cost. If adopted, the Japanese HDTV system would cost as much as did the switch from black-and-white to colour. HDTV viewers would have to buy a new television set to receive the super-quality pictures. Yet broadcasters would still have to transmit separate pictures for people with conventional colour and monochrome sets.

Hence Europe's preference for a system that is evolutionary rather than revolutionary in design — and capable of being received by existing sets fitted with a cheap add-on box.

The European Broadcasting Union has adopted a new family of television standards called MAC (multiplexed analog components), developed by the Independent Broadcasting Authority in Britain. These aim to provide all sorts of future television features — from wide-screen pictures, eight-channel sound and data to direct satellite broadcasting and better definition. The intention is to have MAC pictures compatible with all of Europe's

existing television sets. The motives are not wholly altruistic. European equipment makers have been lobbying their governments hard for fear that if (like the Americans) they accept the Japanese standard, they, too, will kiss their television businesses goodbye — as Sony, Hitachi, Sanyo, Toshiba, Mitsubishi and Matsushita tool up for a global price war in HDTV equipment for studios, transmission and home.

From studio to home

Yet Japan's HDTV and Europe's MAC are not in direct competition. Each represents a set of engineering standards for quite separate things, and serves different sectors of the television industry — which range from programme-making to distribution and display in the home.

HDTV is seen as a studio standard for producers wanting to make features or commercials with the sharpness of 35mm film but taking advantage of the flexibility, faster turn-

around and graphic tricks offered by video tape. Sony, Hitachi and Ikegami are all offering studio equipment based on HDTV standards.

One of the first production companies to buy Sony's \$1m HDTV system was Paris-based Captain Video, which has been using it to supply complex "matting" (ie, special optical effects) that would be too expensive using film, and impractical with the video cameras and recorders used in studios today. The equipment promises production savings of 15-20%. HDTV studio equipment can also offer television stations better "prints" for broadcasting. After a commercial is in the can, successive generations of prints are made of it on 1-inch video tape for distribution — with a loss of quality compounded each time it is re-recorded. An HDTV master tape made to 1,125-line television standards has a definition better than the electronic equivalent of 35mm film, while its conversion to 1-inch distribution tape involves fewer quality-reducing stages. So distribution tapes emerging from HDTV studios tend to be superior to those from film laboratories. But HDTV is not a distribution (ie, transmission) system in a television sense, still less a standard for domestic television sets. True, Japanese officials are proposing a derivative called MUSE for transmitting HDTV pictures — but they have yet to win agreement among equipment makers in Japan, let alone the rest of the world. After that, they will need to develop standards for receiving and displaying HDTV pictures on domestic



Never mind the quality, see the width

television sets. Europe's television engineers have, in contrast, started in the middle. They argue that it is neither the studio nor the home, but the distribution link between them, which is in the greatest mess and needs to be standardised.

Mess? Broadcasters are finding that their medium no longer has a monopoly over the distribution of pictures to the sitting room. Nowadays it has to compete for viewers' time not only with cable television (and soon with two-way interactive cable), but also with video cassettes, video discs, video games, even home computers. Waiting in the wings are awesome new inventions like the CD-ROM (compact disc read-only memory), which stores encyclopedic volumes of pictures, text, music and commentaries, all capable of being interrogated by typing a few simple questions on the screen of a home computer.

Studio in the sky

The television industry everywhere is under the same threat. Its great white hope is DBS — direct broadcasting satellites beaming television programmes and other video delights down to viewers below. In 1977, the World Administrative Radio Conference allocated part of the frequency spectrum above 10 GHz (1 gigahertz is 1,000 megahertz) to satellite broadcasting. Ever since, broadcasters have been waiting impatiently for electronic firms to perfect the special microwave valves — known as travelling wave tubes — that would be powerful enough to transmit pictures direct from space to people's homes.

The most powerful travelling wave tubes for broadcasting satellites look like

being the new 200-watt devices being developed by Thomson-CSF in France and AEG-Telefunken in West Germany. The Mitterrand government had hoped to have its TDF-1 DBS satellite with Thomson tubes in orbit by this year. The schedule has slipped by 18 months to two years, following troubles with the Ariane launcher and a change of heart by France's new conservative government. The French 200-watt tubes have nevertheless been flown in two Japanese experimental satellites, BS-2a and BS-2b. One of these has now gone on the blink and nobody is yet sure how reliable the 200-watt transmitters are.

If they can be made to work properly, DBS systems with 200 watts of power ought to be able to deliver pictures to dishes less than a tenth the size of the ground stations used for telecons today. Unfortunately, even a 1.8 metre dish perched on a rooftop would be unwieldy in a high wind. Mounted on the ground, it would need about half a ton of concrete to keep it steady. In Britain, it would also need to have planning permission. Hence the pressure to develop ever more sensitive receivers — so that domestic dishes can be

reduced to 90cm or even 60cm in diameter. These could be mounted in the loft. Their price would drop from \$1,000 or so for a 1.8-metre dish and its decoder box to around \$350.

At the 1977 conference, five channels plus "parking places" in geosynchronous orbit were allocated to each country in Europe. Britain and West Germany still say they hope to have their DBS services working by 1990. In April, the IBA in Britain started advertising franchises for three (out of Britain's five) DBS channels. The offer closes on August 29th.

But the satellites still have to be built and launched. With the setback to America's shuttle programme and problems stacking up for Europe's own Ariane launcher, few are now putting money on getting DBS services up and running in Europe (or anywhere) by the end of the decade.

Overhaul for telly

Europe's route to high-definition television — and other technological improvements — is via DBS. The reasons are threefold:

- Money. Most broad-

casting authorities in Europe have already had to replace or upgrade much of their existing equipment for terrestrial transmission. They cannot justify upgrading it again for a decade or more.

- Improvements. Though developed later than America's 525-line NTSC colour system (adopted by Japan), both of Europe's 625-line systems, PAL and SECAM, are beginning to show their ages. Television engineers everywhere want to get rid of inherent problems in first-generation colour equipment — like the "edge" and "moiré" effects caused by high-contrast colours on captions and closely-stripped patterns.

- New features. In their battle for the viewers' attention, broadcasters want to be able to market technological refinements that give television an edge over its new video rivals. Top of the list are stereo sound, additional commentary and data channels, wider pictures and higher resolution. The MAC family of standards has been designed to provide all these and more. The principal standard, C-MAC, has been optimised for satellite transmission. The version for cable television is D-MAC. A narrower-band derivative called D2-MAC,

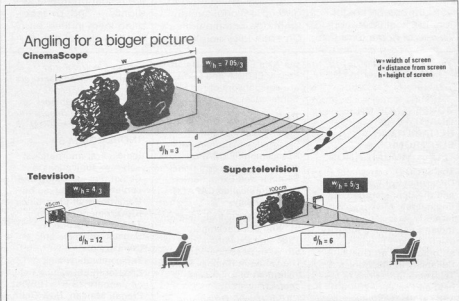

carrying only half the number of sound channels, has been added for early community-wide cable systems.

Television engineers in Europe and Japan differ fundamentally on how they see the television set of the 1990s. Where Japanese engineers expect it to be a bulky box built round a high-resolution cathode ray tube, the Europeans see flat-panel displays more than twice the size of today's largest television screens. The IBA in Britain argues that television tomorrow will be more cinema-like. People are not going to change their sitting rooms, but they will get wider and bigger pictures. The old 4x3 proportions of the cathode ray tube were designed to match the cinema screen of the pre-television era. But in response to competition, film went wider — to the extremes of Cinema-Scope's 7.05x3 proportions before settling down to between 5x3 and 5.5x3 (not far from the 4.85x3 "golden mean" favoured by artists). The new metre-wide flat-panel displays are being developed with heights of 60cm to give cinematic proportions. Another visual effect which television engineers are cribbing from film is image size. The best seats in a cinema are at 3-3.5 times the screen height from the front (see chart). Viewers at home tend to

sit around 10-12 times the screen height from the television set. Given a screen 60cm high, and keeping their seats in the same position, they would be sitting at six to eight times the screen height — close enough in proportional terms to start picking up some of the "lowering" effects produced by cinema's larger images.

Will such a television screen need more than 625 lines? No, say Europe's television planners. HDTV, they argue, is fine for making high-quality videos for big cinema-sized screens. But its 1,125 line resolution is overkill for broadcasting to the home. Displaying even a 35mm film in an "electronic cinema" would need only 800 lines or so. Besides, they say, there are some technological tricks that allow C-MAC to offer the closest thing to HDTV — and still be viewed on existing television sets. So-called "enhanced C-MAC" uses digital tricks and microchips borrowed from the computer industry to get a sharper and bigger picture. To provide the wider 5x3 picture, engineers have borrowed six of C-MAC's eight sound and data channels. Wide-picture viewers would still be able to get stereo sound, but everybody would have to give up optional foreign language commentaries. On each television line,

the sound signals would be sent not as the usual analog waves, but as a Morse-like stream of "digital packets" (akin to a packet-switched data network) transmitting 3m bits of computer data a second. The colour signals would be transmitted separately, one after another, instead of simultaneously but separated slightly in frequency.

All colour television systems (NTSC, PAL or SECAM as well as MAC) use three separate signals to transmit the full range and brightness of the colours. A mixture of red, blue and green (in the proportions 30%, 11% and 59%) is transmitted as the "luminance" signal. This provides the compatibility for black-and-white sets and carries the information used by the eye's monochrome receptors ("rods"). The two additional signals needed to supply the colour are sent as the blue component minus the luminance, and the red minus the luminance. Both trigger the eye's colour sensors ("cones") which have lower resolving power. The trick adopted in the so-called C-MAC/Packets approach is to give the resolution-supplying luminance signal as much room as possible to do its job, while squeezing the colour components slightly — and, by separating them in time, ensuring they do not get in

each other's way. As an optional extra, a "frame store" can be used to dispense with the conventional interlacing process and all its problems. To reduce flickering, alternate lines of the picture have been sent since the beginning of television in the first cycle, followed by the alternate set in the next cycle, and so on. In Europe, that means interlacing 312.5 lines 50 times a second; in America and Japan, 262.5 lines 60 times a second. So the net result is only 25 full frames a second in Europe and 30 frames in America and Japan. However, future television sets could display their full complement of lines (525 or 625) every cycle if they had a frame store to hold, juggle and derive their video signals — and would do so without flicker or any of the side-effects of interlacing. Used in conjunction with enhanced C-MAC, this would be equivalent to 50 full frames being painted on the screen every second. Enough, say its proponents, to give C-MAC more than sufficient picture sharpness to cope with the most demanding of transmissions — while allowing viewers to use their existing sets by buying only a small add-on box.

Reproduced with permission from *The Economist*

Dates for your diary

CONFERENCE ON QUALITY AND RELIABILITY IN ELECTRONICS & TELECOMMUNICATION

The STQC Directorate of the Department of Electronics and the Confederation of Engineering Industry (CEI), formerly Association of Indian Engineering Industry (AIEI) are jointly organising a Conference on Quality & Reliability in Electronics & Telecommunications to be held on February 23-24, 1987 at Vigyan Bhavan, New Delhi, under the auspices of

the Asia Electronics Union, Japan. ELCINA and ITMA are co-sponsors of the Conference.

CAPACIT - 86

Indian Electrical and Electronics Manufacturers' Association (IEEMA) is organising an International Seminar and Exhibition on Capacitors called CAPACIT - 86 in Bombay.

The Seminar will be held on 5th and 6th December, 1986 and Exhibition from 5th - 7th December, 1986. The venue in Bombay is the Institution of Engineers.

contact: CAPACIT - 86 Organising Secretary.

Indian Electrical and Electronics Manufacturers' Association (IEEMA), 501, Kakad Chambers, 312, Dr. Annie Besant Road, Worli, Bombay - 400 018.

INDIA COMM 87

India's first international Telecommunications & Computers exhibition and conference, Endorsed by Department of Electronics (Government of India), Telecommunications Consultants India Ltd. (Ministry of Telecommunications Chapter (IEEE) will be held on January 28-31, 1987 at Pragati Maidan, New Delhi., contact : Mrs. Nita Singh

Executive Officer Confederation of Engineering Industry 172, Jor Bagh, New Delhi 110 003.

INDUSTRIAL INDIA 2001

The 10th National Convention of the Institution of Industrial Managers India is to be held on March 27th & 28th, 1987. The theme of the Convention is INDUSTRIAL INDIA 2001. Please contact : INTERMATECH CONSULTANCY, 43, Satyam (4th Floor), Opposite Odeon, Pant Nagar, Ghatkopar (East), Bombay - 400 075.

TELL-TALE MAGNETISM OF HEART-THROBS

by Mr Donald Longmore, Consultant Clinical Physiologist, National Heart Hospital, London

A team of doctors and scientists working at the Magnetic Resonance Unit of the National Heart and Chest Hospital in London has succeeded in producing pictures of the heart that reveal blood vessels only two millimetres in diameter, never before seen by any non-invasive technique. Moreover, they have developed a procedure to measure accurately various blood flows, opening the way to painless detection of hidden cardiovascular disease before it leads to sudden death.

Nuclear magnetic resonance (NMR) was discovered independently in 1948 by two scientists, Professor Bloch and Professor Purcell, both of whom were working in the USA. They received a joint Nobel Prize for their work. Since then, NMR has been used routinely as an analytical instrument in chemistry.

It was a logical extension of NMR to apply it to studying biochemistry in the living body. Dr Radda, at Oxford University, has been studying this application for a decade; Dr Mansfield, at Nottingham University, was probably the first to produce a human image, in 1976. Magnetic resonance has the greatest potential of any non-invasive technique that has been designed or even envisaged so far. It has been developed mainly as an imaging device to produce pictures of hitherto inaccessible parts of the body in health and disease.

While it is an immensely powerful diagnostic instrument, it has even greater potential in preventive

medicine because it is safe, painless and can be used to screen normal people. About half of all deaths in the western world are caused by one disease process, the blockage of arteries with atheroma, and one-third

are due to cancer. So it is logical to apply magnetic resonance to screening for such diseases. To do that effectively it was necessary to develop the technique to measure the working of the heart and its blood flow.

Dimensional accuracy

The National Heart and Chest Hospitals Group in London has been able to measure these with great accuracy. It first showed the dimensional accuracy of the technique, by using static models called phantoms, designed to mimic the heart chambers. Results from experiments with phantoms showed that it was possible to measure accurately volumes in cavities the size and shape of heart chambers. To study the heart, which is capable of rapid movement, a system of gating the procedure had to be devised and tested. So special, so-called dynamic phantoms were made, to pulse hearts and blood vessels artificially. The ability of MR imaging to 'freeze' motion was shown with a device known as a pulse duplicator which could, at various velocities, inflate a balloon inside a cadaver heart with varying volumes of fluid to simulate its contraction and filling.

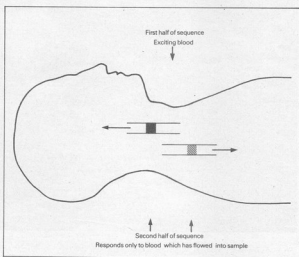

The time-of-flight or downstream-slice technique for measuring blood flow. The spin-echo sequence is performed in halves: first, the pulse to tip the precession of nuclei to 90 degrees is applied to one slice of the body, and the pulse that tips precession by 180 degrees is applied to a slice downstream of the first. Return signal from the body is then obtained only from material that has flowed between the two slices, and not at all from stationary material.

Simulation of the heart's movement in this way was triggered by the electrocardiograph (ECG). The experiment tested the ECG gating and the volume measurements taken on a moving target. It also demonstrated how accurate were measurements on a living heart. Our next step was to prove the technique in Man. To do so, we compared the outputs of the right and left ventricles over a few minutes. The outputs of the two sides of the heart are identical: the basic technique for measuring volume was to measure the areas of contiguous slices of known thickness in the heart and then sum them to find the volume of blood contained within each slice, rather like measuring the areas of slices of bread in a sliced loaf of known and consistent slice thickness. All the volume measurements of heart cavities were accurate to within two per cent. Measurements of heart wall thickness not available from X-rays were also found to be accurate. Although the heart contracts extremely rapidly, the gating technique (using the R-wave, which is the prominent first wave of the ECG) combined with various delays before the MR sequence was applied made it possible to capture the heart when it was at its fullest, its emptiest and at any stage in between. Using the ECG trigger, we found that at least in laboratory experiments it was possible to calculate very accurately the volumes within heart chambers.

To show the clinical value of the technique in Man, the volumes of contracted and filled right and left ventricle chambers were measured in a large number of normal and diseased hearts. Over 256 beats of each heart have to be monitored to provide the data. If no heart valve is leaking and there is no abnormal communication between heart chambers, the two sides of

the heart pump the same amount of blood. Any discrepancy in the measurements must be caused by a defect such as leaking valves or holes between heart chambers. MR was found to be more accurate than nuclear medicine, ultrasound and cardiac catheter techniques for detecting these. There are various ways of measuring the blood flow by MR. Before they are described, we need to take a look at the principle of MR itself.

How does MR work?

In an atom, positively charged and neutral subatomic particles, protons and neutrons respectively, form the nucleus

and the negatively charged electrons orbit about the nucleus at relatively great distances from it, moving at speeds approaching that of light. The particles making up the nuclei spin on their own axes some 40¹⁸ times a minute. The natural spins of protons and neutrons are in opposition; so, in certain atoms where they do not balance one another there is a net positive charge which, although very small, is rotating at a high speed and behaves like a tiny bar magnet which automatically aligns in a magnetic field. Unlike compass needles, in which the North-seeking poles all face North and the South-seeking poles South, atomic nuclei line up with only a very small preponderance of those the correct way round over those the wrong way

round. In a magnetic field of 0.495 T (tesla) the preponderance is only six in one million. The most commonly used nucleus in MR imaging is that of the hydrogen atom. The proton, as well as spinning in line with the magnetic field, precesses rather in the way a child's top wobbles before it runs down. It does this at a precession angle of 54 degrees and at 22 070 700 Hz (hertz). Energy can be fed into the system by applying an electromagnetic radio wave, the magnetic component of which tips the net magnetic moment of the hydrogen nucleus through 90 degrees. This produces a radio signal, also at 22 070 700 Hz, which is picked up by a detector. The rate of precession relates exactly to the strength of the magnetic

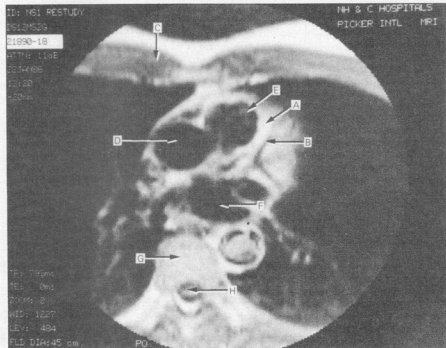

This magnetic resonance picture of a slice 0.5 cm thick through the upper end of the heart (A) was taken recently at the National Heart and Chest Hospitals, London. It is remarkable because the research team has shown, for the first time, detail of the left coronary artery (B) and its branches, some of them of only about two millimetres diameter, by non-invasive scanning. It means that it is now possible to see small coronary arteries and measure the blood flow in them for the diagnosis or prediction of heart disease. Among other details that can be clearly seen are the internal mammary arteries and veins to the chest wall (C); during certain operations on the heart they are sometimes plugged into the coronary vessels to bypass blockages. Prominent in the scan are the left and right ventricular outflow tracts (D, E), the left atrium (F), the backbone (G) and spinal cord (H).

field. This has disadvantages and beneficial effects. It causes the signal given off by the nucleus to disappear quickly because certain chemicals nearby are more strongly magnetic than others, so some protons precess faster than others and the coherency of the signal is lost. Spatial resolution is obtained using the relationship between the rate of precession and the magnetic field: supplementary magnetic gradients are placed across, along, and up and down the field, so that nuclei emitting at one particular frequency must be at a unique place within the patient.

There are three techniques for measuring blood flow. First is called the time-of-flight or downstream-slice technique, in which a thin slice of the patient is subjected to the first half of a sequence, then the second half is applied to a slice at some distance from the first. Only the material that arrives in the second slice and which has been prepared by the first half of the sequence can be seen. By varying the time delays and distances apart of the slices, the velocity of flow can be assessed.

The second technique relies on making a thin slice of the body unsuitable for MR imaging by pulsing it with random signals. That temporarily causes magnetic chaos, so no coherent signal can be obtained from it. An MR signal applied to the slice after a suitable interval will be sensitive only to the magnetically 'clean' material that has flowed into it over that time; the amount of signal at any time relates to the amount of blood or other fluid that has flowed in. The experiment can be repeated with a number of different time delays, producing a graph of signal intensity against flow with a slope that flattens off acutely. The steepness of this slope relates to the flow velocity and the height of the

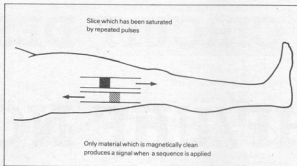

In the saturation technique for measuring blood flow in the body, a slice is saturated magnetically with a pulse tipping the precession to 90 degrees. In a subsequent pulse, only blood that has flowed into the slice gives a signal, because only material that is magnetically clean can do so. The intensity of the signal increases with time until flowing blood has completely replaced the saturated blood, and the rate of that increase reflects the velocity of blood flow. The maximum signal reflects the diameter of the blood vessel.

plateau relates to the diameter of the blood vessel.

Third, and most accurate way of measuring blood flow is to produce an image in the normal way but to apply a magnetic gradient across the body for a certain time, and then to reverse the precession of the nuclei by changing the phase of the radio pulse by 180 degrees, reapplying the magnetic gradient as before. Stationary material

in the sample experiences a phase change related to the magnetic gradient in one direction during the first application of the pulse and in the opposite direction during the second application, so the phase changes in all such material cancel out. But flowing blood moves into a different phase territory during both parts of the sequence, and the change in phase detected from it is proportional to the velocity of

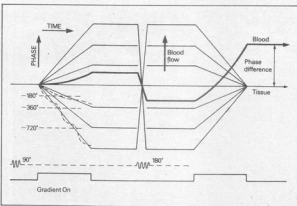

A spin-echo sequence is used in the phase-mapping technique for measuring blood flow. After a radio pulse that tips the precession to 90 degrees has been delivered, a transient magnetic gradient is applied and it alters the phase of the excited material by an amount that depends upon its distance from the selected slice. After the next radio pulse, with its phase changed by 180 degrees, has been applied an identical magnetic gradient to the first is used to restore phase; blood that has moved in the meantime retains a phase proportional to the velocity of its flow. The diagram shows the phase change in blood with the field gradient.

its flow, which can be accurately found with a high special resolution.

Hitherto, there has been no way of measuring blood flow in detail in the most intact vessels, though certain superficial vessels can be studied by Doppler ultrasound. Fortunately, a method of validating the flow technique internally was available from the volume studies already described. A four-way comparison of the output of the right ventricle and the flow in the pulmonary artery, and the output of the left ventricle and the flow in the aorta, allows crosschecks to be made. If all four coincide, the flow sequence is validated. This technique is now being applied to smaller vessels. Experimentally, it is sometimes possible even to measure flow in those moving coronary arteries which are difficult to find.

The diagnostic power that is now available to us, of measuring heart function and blood flow, together with the ability to detect turbulence in the flow of blood mean that it has become possible to understand the natural history of occlusive vascular disease and to study its development throughout life. Much more important is that the technique enables us to monitor the efficacy of drugs that might be used in the control of arterial disease, such as prostacyclin analogues and mitotic inhibitors (which would control the growth of smooth muscle in the arterial wall, an essential step in the formation of atheroma) or a combination of both. It promises to give us a rapid way of finding out whether or not therapeutic substances arrest or reverse the disease. Through these fundamental discoveries, it seems certain that a new generation of MR machines, cheaper and simpler to use, will make an invaluable contribution to eradicating occlusive vascular disease.

VHF/UHF NOISE GENERATOR

Noise is a phenomenon most constructors of RF (and AF) equipment have come to know as an undesirable, yet inherent, property of active devices. Therefore, it is paramount to lay out input stages for minimum noise production, we are told in most textbooks. Then why purposely generate noise when it is to be suppressed with all means available?

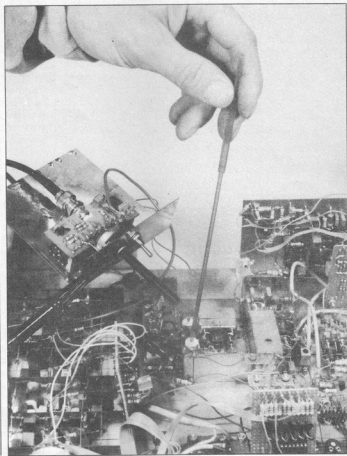

It was already noted in various articles in this magazine that aligning an RF input stage for maximum amplification is not usually the best way of achieving optimum performance if the receiver is to detect input signal levels only just above the noise threshold. Setting-up procedures for receivers therefore commonly finish with some instruction to align the RF input stage for lowest noise, not maximum amplification. But how does one go about doing that?

The present design of a wideband noise generator is based on the principle of audible comparison between receiver and generator noise level. Where day-to-day repeatability is not a prime issue, the generator enables users to quickly find the optimum settings for a variety of receiver types, including FM tuners and home-made VHF/UHF converters; sufficient noise output is available up to about 1000 MHz.

Circuit description

Without going into theoretical details of controlled noise generation, wideband noise is available at K_1 thanks to the apparently random excitation of electrons in the base-emitter junction of SHF transistor T_2

(see Fig. 1). In this design, a current source, T_1 , controls the amount of output noise by passing an adjustable current through T_2 , which has been connected as a zener diode. Monostable multivibrator (MMV) IC₁ can pulse the current source and hence the output noise at K_1 . Continuous output noise is also available by setting S_1 accordingly. A LED has been included to indicate the presence (pulsating or continuous) of noise fed to the receiver. The noise generator is battery-operated and consumes a mere 10 mA, which mainly goes on the account of D_1 .

Construction

Fig. 2 shows the component mounting plan and track layout of PCB Type 86081. Note that K_1 , a single hole type BNC socket, is mounted in a recess hole to allow the threaded part to be soldered straight to the PCB ground plane. This method of construction ensures minimal loss of output noise as well as correct impedance matching to the receiver input.

Two leadless ceramic capacitors, C_4 and C_5 , have been incorporated for adequate RF decoupling and coupling, respectively. If this type of slot-mounted capacitor is new to you, consult *Indoor unit for satellite TV reception-1*, *Elektron India*, November 1986, for information on practical handling.

The noise generator is preferably fitted into an RF-tight metal enclosure. The PCB should be fitted such that K_1 protrudes from a hole in the enclosure rear panel. Controls P_1 , S_1 and S_2 , and the LED, are mounted on the front panel.

Practical use

Initially, set P_1 to maximum noise output, while listening for the increase in AF noise from the receiver. Then reduce the generator output level to a point where it is still 6 dB above the receiver threshold. (6 dB corresponds to about one unit on the receiver's S-meter, provided this is calibrated.)

Switch to pulsed generator noise and align the relevant trimmers or presets in the receiver input stage for a maximum difference between the two audible noise output levels. Since the human ear can discriminate between signals only marginally different regarding level, the proposed method is quite reliable in practice.

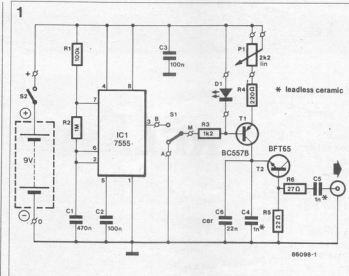

Fig. 1. Circuit diagram of the wideband RF noise generator.

Parts list

Resistors:

- $R_1 = 100\text{ k}$
- $R_2 = 1\text{ M}$
- $R_3 = 1\text{ k}$
- $R_4 = 220\ \Omega$
- $R_5 = 22\ \Omega$
- $R_6 = 27\ \Omega$
- $P_1 = 2\text{ k}2$ potentiometer

Capacitors:

- $C_1 = 470\text{ n}$
- $C_2, C_3 = 100\text{ n}$
- $C_4, C_5 = 1\text{ n}$ leadless ceramic (trapezoidal capacitor)
- $C_6 = 22\text{ n}$ ceramic

Semiconductors:

- $D_1 = \text{LED}$
- $IC_1 = 7555$
- $T_1 = \text{BC557B}$
- $T_2 = \text{BFT65}$

Miscellaneous:

- $S_1 =$ miniature SPDT switch
- $S_2 =$ miniature SPST switch
- $K_1 =$ single-hole BNC socket
- PP3 battery 9 V plus clip
- PCB Type 86081 (see Readers Services)
- Suitable metal enclosure

2

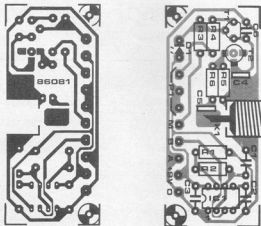

Fig. 2. PCB Type 86081 has been designed to meet the demands of very-high frequency design. Note that BNC socket K_1 forms an integral part of the completed board.

Fig. 3 shows the periodically switched noise from the generator over the full 0-1 GHz output band. The high pulse levels on the spectrum analyzer screen correspond to noise output from the generator, the low pulse levels correspond to the analyzer's internal noise threshold. Although the actual increase in noise is relatively small, the fact that it is pulsed rather than constant promotes the audible effect in the receiver.

Finally, it should be noted that the generator output noise level falls with increasing frequency; at the highest UHF TV channel (about 800 MHz), however, input stage alignment is still possible, provided there is no excessive cable loss between K_1 and the receiver input.

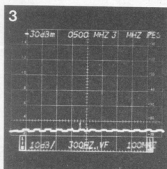

Fig. 3. Pulsed noise, integrated by means of the spectrum analyzer's 300 Hz video filter. As can be seen from the set sweep range, noise is available over the entire 0-1 GHz band. The small peak at about 460 MHz was caused by a local cellular radio relay station.

Press a button, and the lift starts moving. Press a button and the motor starts running. How does just a small push on the tiny button cause a heavy object to move? Here, a small control current causes a heavy current to be switched on or off - typically through a relay contact.

Every relay consists of two main functional parts: one electromagnet and one or more switches. Even a door bell can be thought of as a vibrating relay. The equivalent circuit is shown in figure 1 to illustrate the comparison. The electromagnet consists of an iron core and a coil wound on that. The rectangle with an oblique line shown in the figure is the standard symbol for a relay coil.

In modern electronic circuits, the relay as shown in figure 2 is very commonly used. Such a relay has more than one contacts which are mostly change over type. A small current flowing through the electromagnet coil can activate these contacts to change over from one position to other. The normally open contacts will close and the normally closed contacts will open. Such a relay may require a coil current between 20 and 200 mA. The operating voltage is generally 6V, 12V or 24V etc. The higher is the voltage, the lower is the current.

Figure 3 shows the modern type of miniaturised 'Reed Relay'. These relays have generally only one contact installed in a hermetically sealed glass tube. The coil is wound around the tube. A small current of about 10 to 20 mA is enough to operate a reed relay.

Figure 4 shows a different type of relay. This relay is used to operate a siren and the principle is somewhat similar to that of the doorbell. One end of the relay contact is connected to the relay coil itself.

RELAYS

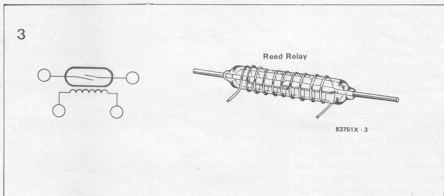
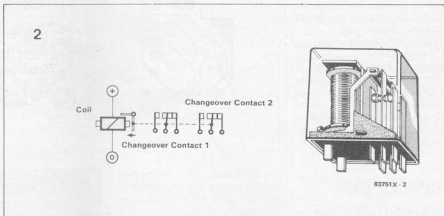
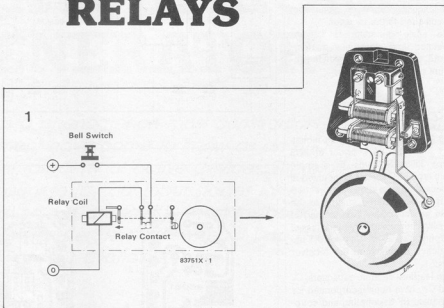



Pressing the switch energises the coil momentarily and this activates the contact to change over and break the circuit. This throws the relay contact into oscillations and the siren is activated. The current requirement of such a relay is very high (about 500 mA)

Many more types of relays are in use, and a small "collection" of such relays is shown in figure 5. If you come across an unknown type of relay and want to establish its nature, first open the cover. Then, press the small lever which appears just above the coil with a finger. From this you can make out two things. One is the type of contacts - normally open and normally closed, and second is the force required to press the lever which, in actual operation, will be supplied by the electromagnet coil. The greater is the required force - the greater must be the operating voltage (or current) for the relay.

Next step is to check if any code numbers are marked on the coil. The code number may have the voltage, current or the coil resistance value embedded into it. If you find more than two terminals coming out of the coil, you must see the resistance across the different pairs of terminals and finally try them out! A

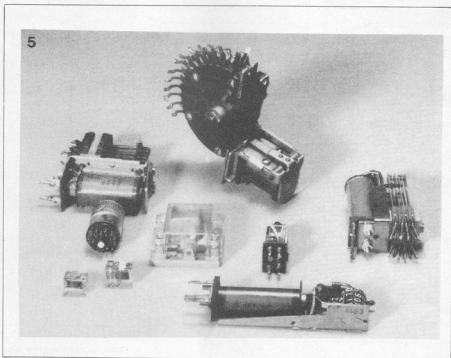

battery can be connected directly across the relay coil terminals momentarily to see the effect.

Figure 6 shows an important requirement when operating a relay with a driving transistor. A diode must be connected in parallel connection with the coil. This is required to allow a passage to the reverse e.m.f. generated during the operation of relay.

4

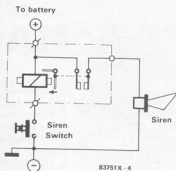

6

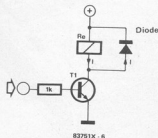

WIRE MOVEMENT IN A MAGNETIC FIELD

We have already seen how a high current flowing through two adjacent wires produces movement between the two wires. The reverse is also true. Movement of wires can also generate current. In fact this is the basic principle of modern power generation.

One of the most simple arrangements to illustrate this principle is shown in figure 1. Let us call it the wire trapeze! This wire trapeze swings between the two poles of a horse shoe magnet. The movement of wire in the magnetic field causes a voltage to be

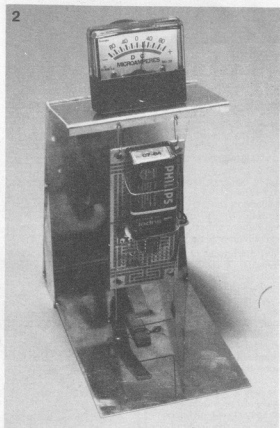
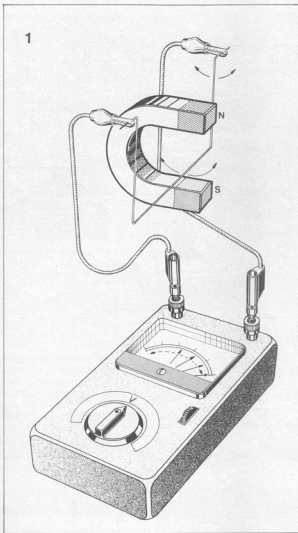

induced across the wire and thus a current flows the wire if the circuit is completed.

The induced voltage is however very small. The magnitude is about 0.0001 V. We can measure such tiny voltages by using a suitable amplifier stage between the wire trapeze and the Meter.

Figure 2 shows a practical arrangement which can measure the induced voltage. The wire trapeze as well as the amplifier. Stage is built on SELEX PCB.

Figure 1:
The movement of a wire trapeze in the magnetic field of the horse shoe shaped magnet induces a voltage.

Figure 2:
An operational amplifier with high gain is used to amplify the induced voltage. The wire trapeze is directly soldered on the PCB.

The Amplifier used is the 741 IC, which is the most commonly used Operational Amplifier.

It requires only a couple of additional components to be externally connected, as shown in figure 3. The non inverted input (+) is connected to a voltage divider made of two $1K\Omega$ resistors, which halves the battery voltage. The moving wire is connected between the (+) and (-) inputs for amplifying the induced voltage through the 741 IC. The amplification factor or the gain is determined by R_4 and R_3 and in this case it is 10,000. For a clear deflection of the needle, a low voltage range, i.e. 3V or even 1V can be selected. The trimpot P1 is adjusted in such a manner that the meter indicates a positive voltage. Since positive and negative voltages would be indicated, this adjustment is quite critical.

Figure 4 shows the component layout using SELEX PCB. An 8-pin DIL socket should be used for the IC 741 and proper position of the markings should be observed. Connecting wires to the meter should be long enough and flexible, so that they do not obstruct the movement of the swinging PCB (The PCB itself is used as a trapeze in this case).

A number of interesting trials can be carried out with this construction. The magnets can be changed, amplitude of swing can be changed and also the direction of magnetic field can be changed. It can be observed that the magnitude of deflection changes for each trial but one thing remains constant: the nature of deflection. The direction of deflection of the needle changes with change in direction of movement of the wire in magnetic field. Thus we can see the wire trapeze to be a generator of AC voltage. We can also use different types of construction for the moving wire and see the effect on induced voltage. The efficiency of the swinging wire increases considerably when it is made to form several loops, (as in a coil) because the voltage produced in every loop adds up to give a higher induced voltage. This arrangement is shown in figure 5. The experiment can also be conducted by using a different kind of magnet. The horse shoe shaped magnet can be replaced by an electromagnet or a coil having about 8 to 10 turns and connected to a 4.5V - battery. In this experiment, however, the battery will have to supply a heavy current.

Another interesting arrangement is shown in figure 6. Here the conductor loop stands still, but the coil forming the electromagnet is connected to the battery for a very short period and disconnected. Due to this, a high current flows through the coil momentarily. The meter needle shows a clear deflection as in all previous cases. This proves an important aspect, that for inducing a voltage the movement is not physically important but what is important is the change in the magnetic field which is cut by the wire or the loops of wire. Whether the change in field is a result of movement of wire or through change in current flowing through the electromagnet coil is not important.

The last experiment also illustrates the basic principle of the transformer. The voltage across the electromagnet coil produces a magnetic field which cuts the wire loops connected to the meter circuit. The change in this magnetic field induces a voltage across the wire loops, which is known as the induced voltage. This is nothing but the transformer action — which induces a voltage in the secondary winding depending on voltage across the primary

4

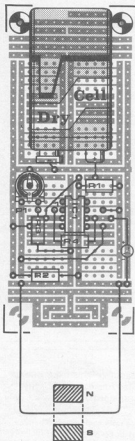

3

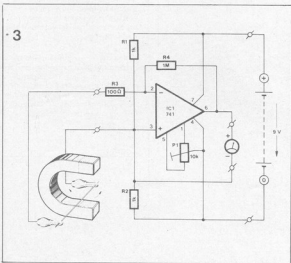

Figure 3:
The Amplifier circuit using the Operational amplifier IC 741, and a few external components.

Figure 4:
The component layout on SELEX PCB. Even the battery can comfortably fit on to the PCB.

Component List

- R1, R2 = $1K\Omega$
- R3 = 100Ω
- R4 = $1M\Omega$
- P1 = $10K\Omega$ Trimpot.
- TC1 = 741 Op-Amp.

Other parts :

- 1 Standard SELEX PCB 40 mm x 100 mm
- 1 8-pin DIL socket
- 1 9V battery pack
- 1 battery clip
- 1 4.5V battery pack
- 1 Meter/ Multimeter
- 1 Horse Shoe shaped Magnet

5

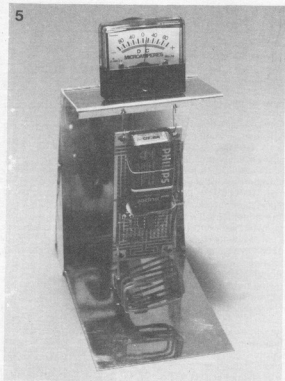

6

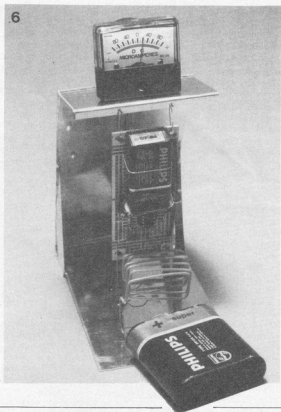

winding. This experiment also makes it clear why transformers can work only with AC voltages.

In case of practical transformers, the coils or the windings are placed around an iron core, through which the magnetic field is concentrated. In a most commonly used step down transformer, the AC Mains voltage is connected to the primary winding and output is taken across the secondary winding which has less number of loops (turns) than in the primary winding. Thus the induced voltage in secondary winding is less than the mains voltage.

7

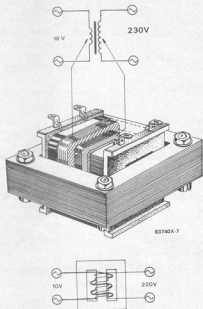

Figure 5: The induced voltage increases proportionally when the number of loops of wire are increased.

Figure 6: The horse shoe shaped magnet is replaced by an electro-magnet. A momentary current through the electro-magnet coil induces a voltage in the wire loop and produces a clear deflection of the meter needle.

Figure 7: A transformer is constructed by placing the primary and secondary windings on a core made out of Iron Stampings. The Core concentrates the magnetic field in the windings and avoids loss of magnetic energy.

BICYCLE DYNAMO



A Bicycle Dynamo is a generator of AC voltage. Even the giant power house generators operate on the same principle as that of the bicycle dynamo: a voltage is induced in a coil if the magnetic field passing through it is made to change.

In case of the bicycle dynamo, the coil is fixed and a magnet is rotated in front of the coil. The alternate magnetic poles running across the coil make the magnetic field through the coil to change. This induces an alternating voltage in the coil to supply the current required by the small lamp.

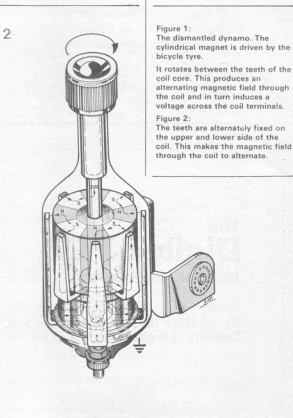
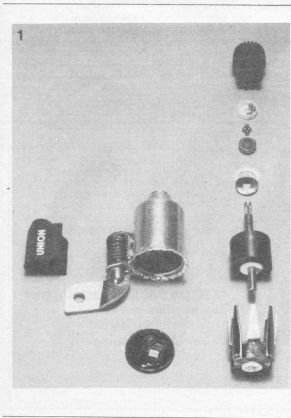

Figure 1:
The dismantled dynamo. The cylindrical magnet is driven by the bicycle tyre.

It rotates between the teeth of the coil core. This produces an alternating magnetic field through the coil and in turn induces a voltage across the coil terminals.

Figure 2:
The teeth are alternately fixed on the upper and lower side of the coil. This makes the magnetic field through the coil to alternate.

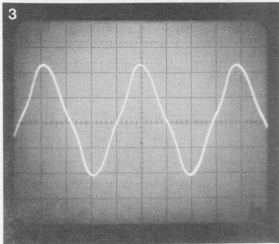

Figure 3:

The waveform of the dynamo voltage as seen on an oscilloscope screen. The waveform shows eight halfwaves per rotation of the dynamo. The waveform is not exactly sinusoidal but is a little distorted. The power house generators produce a sinusoidal voltage.

Let us dismantle a bicycle dynamo and see what happens inside it. The dynamo indeed contains a magnet and a coil, but the coil is not in front of the magnetic pole faces as expected. It lies below the cylindrical magnet.

How does it induce the voltage then? A bit confusing!

The solution to this puzzle however lies in the two crown like rims made of iron plate. These sheet metal teeth allow the magnetic field from the

rotating magnet to pass through the coil at the bottom. Four teeth are fixed at the upper end of the coil and four at the lower end. The cylindrical magnet has eight poles; four north poles & four south poles - placed alternately along the

circumference. Due to this arrangement, the four upper teeth are always faced with the same type of poles and the four lower teeth are faced with the opposite type of poles. Thus on rotating the magnet, the upper teeth alternately face north and south poles, whereas the lower teeth alternately face south and north poles. The field in the coil is continuously reversed four times per rotation. This continuously changing magnetic field causes an alternating voltage to be induced across the coil terminals. The proof of this can be seen in figure 3. This is how the waveform of the dynamo voltage looks like, on an oscilloscope screen. Eight half waves are produced per rotation. The frequency depends on the speed of the bicycle. Open circuit voltage of the dynamo is roughly around 12V which drops to 6V when a 3W lamp is connected.

Even the car dynamo works on the same principle. Only change being that it does not have a permanent magnet but has an electromagnet. The current through the electromagnet coil is regulated to produce a stable voltage.

The Digilex-PCB is now available!

Price:

Rs. 85.00 + Maharashtra Sales Tax.
Delivery charges extra: Rs. 6.00

Send full amount by **DD/MO/PO**.

Available from:

precious[®]

**ELECTRONICS CORPORATION
 Journal Division**

11, Shamrao Vithal Marg (Kiln Lane)
 Off Lamington Road, Bombay-400 007.

elektor INDIA Kits



LCD Thermometer Issue No. 26 EPS No. 82156

Simple! Easy to assemble. Based on IC 7106 This thermometer is very accurate with a temperature range - 50°C to + 150°C. Ideal for house or laboratory.

Complete kit (with cabinet)
Rs. 575.00

Capacitance Meter Issue No. 11 EPS No. 811012 - 1/2

To measure those elusive farads, this project features

- Read out on a 3 1/2 digit LCD
- A measuring range from 0.1 pf to 20 mfd.
- high accuracy.

It is a complete instrument at a hobbyists price Complete kit (without cabinet) Rs. 750.00

Digilex Digital Trainer

Teach yourself digital electronics in a simple, unique manner. Broaden your horizons and improve your fundamental understanding of the changing world of electronics around you. This trainer gives you an opportunity to learn electronics at a very reasonable cost.

Complete trainer at Rs. 325.00

Junior Computer Kit

This kit enables you to have a practical orientation of the concepts explained in the Junior Computer Book I. Get actual 'hands — on' experience. Learn the basics of hardware and software in an innovative step - by - step manner.

And that too at an incredibly low price!

Complete kit (without cabinet)
Rs. 1500.00

Elektor Binder — This reddish binder collects your loose copies of Elektor into one handy volume. A

simple system enables you to add each copy as it arrives and to remove a single copy without disturbing the others.

Price Rs. 25.00 plus Rs. 5 for Packing & Postage.

Kits currently available

Issue No.	EPS No.	Title	Price.
33	85110	Telephone Exchange	Rs. 1200.00
36	9827	Magnetiser	Rs. 65.00
37	80054	Talk Funny	Rs. 210.00
39	86013	Single Trace CRT Converter	Rs. 190.00
39	9967	VHF/VHF Modulator	Rs. 105.00
28/29	85447	Fault finding probe for Ups.	Rs. 60.00
28/29	85431	Hi-fi headphone amplifier	Rs. 75.00
28/29	85476	Brakelight Monitor	Rs. 25.00
28/29	85448	Electronic Dog	Rs. 180.00

Buying one of our kits will save you the frustration of tracking down those elusive components that hold up your projects. General Information.

Ordering Information

1. All payments in Advance by M.O.R.O. or D.D. only.
2. Items will be send by R.P.P. only
3. Price includes Packing & Postage.
4. For orders out of Maharashtra state, Please add 10% as a 'incidental Charges' Send payment to:

precious[®]
ELECTRONICS CORPORATION

Journal Division 11, Klin Lane, Off, Lamington Road, Bombay - 400 007.

NEW PRODUCTS

WIRE WOUND POTENTIOMETER

SSI have introduced single turn wire wound potentiometers for various applications. Available in all standard values from 10 ohms to 25K ohms with $\pm 10\%$ tolerance, the potentiometer is rated at 1W at 40°C and derated to zero at 125°C. Operable in a temperature range of 10°C to 85°C, it has a Ni-Cu alloy wire for close tolerance and low temperature co-efficient of resistivity.



For further details, please write to:

SOLID STATE INDUSTRIES,
1, Narayan Bhavan,
Jivdani Road, Virar (E),
Dist: Thane.

ADORGUARD

Advani Oerlikon have developed a 4 point Alarm Annunciator Panel the ADORGUARD for application in petrochemical, fertilizer, steel plants, thermal power stations and other continuous process industries. The instrument provides continuous audio visual indication of faults.

The Adorguard is solid state device capable of withstanding

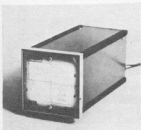

vibrations and shocks and working on 24V DC / 18V AC 1-0. Further, it is compact, immune to noise, and panel mounting type for occupying minimum space. For complex systems, multiples of this unit can be grouped together for use

For further information, write quoting Ref. No. P/315/86 to:
M/S. ADVANI OERLIKON LTD
Post Box No. 1546
Bombay - 400 001

CABLE BINDERS

These binders (saddles & clips) are manufactured in thermoplastic and Nylon and have high insulation values. Modification of cable looms can be done quickly. Due to high grade material it combines the right degree of toughness with the necessary flexibility to hold any type of cables securely without damage.



For further details contact:-
M/S. STARLITE ENTERPRISES,
124B, Vivekananda Road,
Calcutta - 700 006.

ELECTRONIC FILLING CUM WEIGHING MACHINE

Delinters India have developed an Electronic filling cum weighing machine for on line continuous feeding, weighing and packaging operations. Useful for quantities between 100gms & 7 Kgs (a version for 10 Kgs 50 Kgs is also available) the machine is suitable for solids like granules, crystals, seeds, flakes, pellets and powders.

The machine has several features viz. single operator is required, presence of counting device, digital display for weight, fast/slow dribble action for feeding, and voltage stabilization. The unit can be



hooked to a small computer and printer for daily packaging reports.

For further information, please contact

DELINTERS INDIA
Pratap Road, Raopura
Vadodra-390 001.

M/s. Luxco Electronics, Allahabad, pioneers in the manufacture of speakers have introduced speakers suitable for any automobile. The speakers are supplied in different sizes, to suit internal design of different types of automobiles. Normally the sizes in 6 1/4" and 4" x 6" type of speakers are available. These speakers are supplied in four different ratings to deliver 12 Watts, 20 Watts, 40 Watts and 60 Watts total power output. These speakers perfectly match with any sophisticated world class Moni Mono Stereo tape decks. The uniqueness of these speakers is that they are marketed as a complete system consisting pair of speakers grill, cords and template. They are scientifically packed in thermocolle packing to protect against transit shocks and are housed in polyaminated packing for added grace.



contact :
Distributor for South and West:
M/s Precious Electronics Corporation
Chotani Building
52-C Proctor Road Grant Road
(East) BOMBAY - 400 007.

PLASTIC MOULDED INSTRUMENT BOX FOR BACK MOUNTING : TYPE T-77

'Comtech T-77' is an elegantly designed plastic moulded instruments box suitable for back mounted instruments such

as Timers, & various other control instruments, having overall dimensions of 110mm. L x 77mm W x 100mm. B. It consists of a moulded box, a cover, & a M.S. plate for back mounting. The box has an inside space 73mm. X 71 mm. For various components. A six way terminal strip fixed at the top & bottom, in front of the box provides an easy access for the terminals. The cover can accommodate a PCB of 77 mm x 72 mm. from inside & has a 1.2 mm deep recess in front to take an Aluminium plate of 65 mm x 66 mm. for control indications, the box offered in Black & Grey colour with either Glossy or Matt finish, is most suitable for small instruments to be mounted side by side from the back, like e.g. counters, controllers & timers etc.

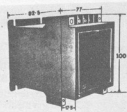

For further details contact:
COMPONENT TECHNIQUE
8, Orion Apartment
29-A Lalubhai Park Road
Andheri (West)
Bombay-400 058

PCB TERMINALS

ELCOM offers a new PCB mounted screw terminal block. It is available as a standard 3 pin module, which is stackable in multiples of 3 without disturbing the 5 mm. Pitch. The pin diameter is 1 mm. and the maximum wire size that can be used with the block is 2.5 square mm. Current rating is 10 A at 380 V (RMS).

Maximum operating temperature is 100°C.

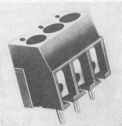

For further information :
ELCOM
103, Jaygopal Industrial Estate, B. Parulekar Marg, Dadar, Bombay 400 028.

CTR

Require

DESIGN ENGINEER: BE/DEE/SERE with minimum experience in Design, Research and Development of professional grade components, preferably Capacitors. Must be conversant with IS, BS, DIN, IEC, MIL specifications and latest technology. Age: 35 years. Minimum emoluments Rs. 2000.00 per month with subsidised housing.

Candidates meeting the above requirements need only apply. Excellent prospects for the right candidate. Apply in English in your own hand writing to:

*Personnel & Administrative Manager
CTR Mfg Ind Ltd
E1, Chikalthana
Aurangabad 431210*

Required

SALESMEN

**with Electronic
background**

**apply
Sales Manager,
P.O. Box 9122
Bombay-25**

Bharat Bijlee

**ELECTRONIC
ENGINEERS**

**Research & Development
Design & Development
Marketing**

Thane

**Rs. 24,000 to Rs. 36,000 p.a.
+ perks**

Bharat Bijlee Limited, a leader in the Electrical Engineering Industry with professional management and an annual turnover of Rs. 40 crores needs Electronic Engineers for its R&D Centre and Electronics Control Division.

For R&D Centre, graduate or post-graduate Engineers with specialization in Industrial Electronics, Power Electronics, Process Controls or Micro-processors and with about 5 years' experience in design and development of electronic controls, are eligible.

For Electronics Control Division, qualified electronic engineers with minimum 2 years' experience in marketing of industrial electronic products will be preferred. Alternatively, Electrical Engineers with 2-4 years' experience of marketing of industrial products with an aptitude for application engineering oriented marketing in electronics can also be considered.

Selected candidates will have good prospects of advancement. Emoluments, designation and status will be commensurate with qualifications and experience.

Please apply, within 10 days, giving details of age, qualifications, nature and length of experience, present and expected salary with break-up, marking the envelope "Electronic Engineer" to:



The General Manager (Personnel)
Bharat Bijlee Limited
P B 100, Kalwa, Thane 400 601
Maharashtra

Our advertisers will be pleased to know that our circulation has been steadily growing and our print order is now 16500 copies.

You will also be pleased to know that our circulation will be certified by ABC shortly.

Our advertising rates have remained the same since the first issue of *elektor-India* in May 1983. We now find it difficult to continue the same rates in view of the escalating costs of every input that goes into publishing *elektor-India*.

The new advertising rates with effect from 01-01-1987 are given below:

34 February 1986 **elektor** (INDIA) Rs. 7.50
electronics

40/41 **elektor** (INDIA) Rs. 5.00
electronics

NEW ADVERTISING RATES

	Black & White	Four Colours
FULL PAGE	Rs. 3000/-	
HALF PAGE	Rs. 1700/-	
QTR. PAGE	Rs. 900/-	
1st Inside Cover	Rs. 4000-00	Rs. 6000-00
1/nd Inside Cover	Rs. 3800-00	Rs. 5500-00
Back Page	Rs. 4500-00	Rs. 7000-00
Double spread	Rs. 5800-00	
Opening Full Page	Rs. 3500-00	

Contracts placed before 31st December, 1986 will be honoured at the prevailing rates.

THE BEST DESIGNED...

MECO

NEW

DIGITAL PANEL METERS



LIQUID CRYSTAL DISPLAY TYPE

- 3½ Digits
- 4½ Digits
- Full scale input with sensitivity of + 200mV



modpu 63



L.E.D. TYPE

- 3½, 4½ digits
- 5 digit Frequency Meter.

MECO INSTRUMENTS PRIVATE LTD.

Bharat Industrial Estate, T.J. Road, Sewree, Bombay-400 015. Telex: 011-71001 MECO IN
 Phones: 413-7423, 413-2435, Cable: "STANCOR"

8085 MICROPROCESSOR TRAINER built in EPROM programmer, power supply, 2K CMOS/RAM with dry cell back up expandable to 8 K, 12 K user EPROM installed Rs. 2975/- All inclusive. EPROM Eraser Rs. 500/- Contact: NEW AGE ELECTRONICS, Third Floor, Laxmi Mahal, Near Vandana Cinema, Agra Road, Thane - 400 602.

Available Printer Interface card for 460 mechanism. Input 10 digit parallel BCD with Real time calendar clock & self test facility. Open execution without Printer for Rs. 3500/- only. Contact: Process & Control Elements, 111A, Hind Saurashtra Industrial Estate, Marol Naka, Andheri (E), Bombay-400 059 Ph: 6326579.

Available 44 pin .1" card edge connectors O/E/N, Part No. 04U-22-15-235-20-84 for Rs. 55/- + taxes. Delivery Ex stock. Limited quantity available. Payment through bank, Contact: SILICON-AIDS, 111A, Hind Saurashtra Industrial Estate, Marol Naka, Andheri (E), Bombay-400 059 Ph. 6326579.

ACE COMPONENTS	12.68
AIR INDIA	12.09
ARADHANA ELECTRONICS	12.68
APEX ELECTRONICS	12.69
APPOINTMENTS	12.61
COMTECH	12.08
CYCLO	12.12
DEWAN RADIO	12.06
DEVICE ELECTRONICS	12.63
DYNALOG MICRO SYSTEMS ..	12.76
ELCIAR	12.64
ELECTRONICA	12.08
ELTEC BOOKS N KITS	12.10
GALAXY ELECTRONICS	12.69
GENERAL ELECTRONICS	12.04
GRAFICA DISPLAY	12.12
IEAP	12.68
INSTRUMENT CONTROL	12.69
JETRONICS	12.69
J.M. ENTERPRISES	12.13
KIRLOSKAR	12.11
LEADER ELECTRONICS	12.72
LUXCO ELECTRONICS	12.07
MECO INSTRUMENTS	12.67
MELTRON	12.18
NAVIN FLUORINE IND	12.75
NCS ELECTRONICS	12.70
PHILIPS	12.14
PIONEER ELECTRONICS	12.70
PRECIOUS	12.59 12.72
ROCHER ELECTRONICS	12.06
SAINI ELECTRONICS	12.64
SMJ ELECTRONICS	12.73
SUPERB PRODUCTS ..	12.10 12.70
TEJUTRON	12.72
TEXONIC INSTRUMENTS	12.10
THERMAX	12.12
TRIMURTI ELECTRONICS	12.64
VASAVI ELECTRONICS	12.02
VISHA ELECTRONICS	12.03
VISTAR ELECTRONICS	12.08
ZENITH	12.65

IMPORTANT

SUBSCRIPTION RENEWALS ARE ON!

HAVE YOU RENEWED YOURS?

Rates are still the same:

1 One year
Rs. 75-00

2 Two years
Rs. 140-00

3 Three years
Rs. 200-00

Remember:

- To use the card in this issue
- To quote your subscription number
- To mention that it is a renewal
- To send your renewal at least one month in advance
- Timely renewal ensures continuous receipt of issues without irritating breaks

elektor
electronics

Now
available
ex-stock to actual
users from Export House

FLUOROCARBON₁₁₃

(Trichlorotrifluoroethane)
and its Methanol Azeotrope

the ideal cleaning solvent used worldwide by the
Electronic Industry



FLUOROCARBON₁₁₃
EXCELLENT
CLEANING
AGENT

Precision Parts



General Metal Parts



Plastic Parts



Dry Cleaning



Actual users please contact:

NFI Navin Fluorine Industries

Chemical Division of THE MAFATLAL FINE SPG. & MFG. CO. LTD.

Maflatal Centre, Nariman Point, Bombay 400 021. Tel: 2024547 Grams: MAFINISED Telex: 011-4241 MGMC IN

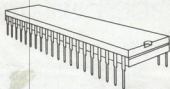

WHICH Microprocessor?

Microprocessors are now being used in a wide range of products, from Mixers and Washing Machines to highly sophisticated Industrial Robots. Have you decided which microprocessor you will be using for your new products? Will it be 8085, Z-80, 8086, 8088, 6802, 6502 or will it be the powerful 32-Bit 68000?

Whichever Microprocessor you select, Dynalog has a suitable Training and Development System for that Chip.



Training And Development Systems Based On : 8085, Z-80, 8086, 8088, 6802, 6502 And 68000.

Dynalog Micro Systems offer you the most comprehensive range of Microprocessor Training and Development Systems. Starting with the Low Cost Systems based on 8085, Z-80 and 8088, the Top of the range covers Single Board Computers based on 6502 and Z-80, and a Full Fledged Single Board Development System based on 68000. The Single Board Computer-Super 80 based on Z-80 has on board interfaces for Centronics Printer, Video Monitor, ASCII Keyboard, RS-232-C Serial Communications and Floppy Disk Drives of both 5 $\frac{1}{4}$ and 8 inch types. It is fully compatible with CP/M Operating System. The standard features of the MICROFRIEND Series Training and Development Systems include Hex Keypad, Seven Segment LED Displays, On board EPROM Programmer, Timer/Counters, Parallel and Serial I/O Ports, STD Bus on edge connector, Powerful Monitor Firmware in EPROM, Detailed Documentation/Operating Manuals etc. Systems like the MICROFRIEND-III also offer facilities for programming in BASIC, FORTH or 8085 ASSEMBLY LANGUAGE with built in interfaces for Video Monitor, ASCII Keyboard and Printer.

Dynalog Micro-Systems

14, Hanuman Terrace, Tara Temple Lane,
Lamington Road, Bombay 400 007

Tel: 362421, 353029 Telex: 011-71801 DYNA IN Gram: ELMADEVICE
Branches and representatives at: Pune, Bangalore, New Delhi, Hyderabad and Chandigarh